

KATALOG



RADEX POLAND SP. Z O.O. SP. K.
ul. Komunalna 2, 14-200 Iława, Polska

+48 89 648 75 01
+48 89 644 82 88
SPRZEDAZ@RADEX.COM
WWW.RADEX.COM

This publication does not constitute an offer within the meaning of the law and was made for information purposes only.

The manufacturer reserves the right to change the construction of the product.
NOTE: Due to the technique of printing colors in this catalog may be different from the real ones.

Edition I/2019



RADEX®

Doors for people with passion



RADEX®

*Doors for people
with passion*

TABLE OF CONTENTS

ABOUT US

ABOUT THE COMPANY.....2

RADEX **DIY**

EKO.....4
ETNA.....6
GENEWA.....8

RADEX **CLASSIC**

NORMANDIA.....10
BERGEN.....12
CZAPLA.....14
IŁAWA.....16
LIZBONA.....18
LONDYN.....20
LUGANO.....22
VERONA.....24

RADEX **FOG**

ISTRIA.....26
MANHATTAN.....28
TRYPLET.....30
TURYN.....32

RADEX **PREMIUM**

MARBELLA.....34
MALAGA.....36
MILANO.....38
NEFRYT.....40
ROMA.....42
TOSSA.....44

RADEX **LOFT**

LOFT I.....46
LOFT II.....48
LOFT X.....50
LOFT Z.....52
LOFT XI.....54
LOFT XX.....56
LOFT OX.....58

ACCESSORIES **LOFT**

REA SLIDING SYSTEM.....62
LUNA SLIDING SYSTEM.....63
IZYDA SLIDING SYSTEM.....64
TEMIDA SLIDING SYSTEM.....65
ADDITIONAL ACCESSORIES.....66

DOOR FRAMES

FIXED KNOTTED.....72
FIXED KNOTLESS.....73
ADJUSTABLE KNOTTED.....74
ADJUSTABLE KNOTLESS.....75
ADJUSTABLE KNOTTED DECORATIVE.....76
STRIPS AND QUARTER ROUNDS.....77
POSSIBLE FINISHING.....78

ACCESSORIES RADEX

WALL SYSTEM.....82
UNDERCUTS, VENTILATION TUBES AND LOCKS.....84
WOODEN DOORS DIMENSION.....85

ABOUT THE COMPANY

We are one of the leading manufacturers of wooden doors, frames and attic stairs. The company was established in 1986 in Iława, a picturesquely located town in the Warmińsko-Mazurskie Voivodeship. Thanks to efficient management and constant investments, RADEX has quickly become an important producer of doors and attic stairs on the European market. Our company is a dynamically developing company in its sector. You will find our products in the largest retail chains in Poland and many European countries.





WOODEN DOORS

WOODEN DOORS

EKO - pine

PRODUCT SPECIFICATION

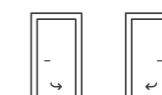

ECO DOOR.PN.80P, ROUGH



ECO DOOR.1S.80P, ROUGH



ECO DOOR.6S.80P, ROUGH

DOOR STRUCTURE

Frame and panel of the door made of glued Scandinavian pine.

STANDARD EQUIPMENT

- + Door with rebate
- + Not glazed door
- + Hinges in silver color
- + Locks:
 - full door: insert lock
 - Door 1 glass: bathroom lock
 - door 6 glasses: simple lock

FRAMES, MASKING STRIPS AND ACCESSORIES*

- + Adjustable knotted frame (simple/decorative)
- + Fixed knotted frame
- + Knotted masking strip (simple/decorative)

* door frames, masking strips and accessories - details on pages 74-86

AVAILABLE DIMENSIONS

- + 70 (bathroom door)
- + 80 (others)

AVAILABLE TYPES OF FINISHING

Rough

ADDITIONAL OPTIONS

Lack

APPROVALS

The door complies with the current building standard - Technical Approval No. AT-15-6912/2016.





ETNA - pine

WOODEN DOORS

WOODEN DOORS

PRODUCT SPECIFICATION

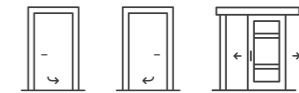

ETNA DOOR.PN.80P, ROUGH



ETNA DOOR.2S.80P, ROUGH



ETNA DOOR.6S.80P, ROUGH

DOOR STRUCTURE

Frame and panel of the door made of glued Scandinavian pine.

STANDARD EQUIPMENT

- + Door with rebate
- + Glazed versions: 4 mm milky tempered glass
- + Hinges in silver color
- + Locks:
 - full door: insert lock
 - door 2 glasses: bathroom lock
 - door 6 glasses: simple lock

FRAMES, MASKING STRIPS AND ACCESSORIES*

- + Adjustable knotted frame (simple/decorative)
- + Fixed knotted frame
- + Knotted masking strip (simple/decorative)
- + Wall-mounted, sliding, masking systems

* door frames, masking strips and accessories - details on pages 74-86

AVAILABLE DIMENSIONS

- + 70 (bathroom door)
- + 80 (others)

AVAILABLE TYPES OF FINISHING

Rough

ADDITIONAL OPTIONS

Lack

APPROVALS

The door complies with the current building standard - Technical Approval No. AT-15-6912/2016.

GLAZING - TEMPERED MILK GLASS





GENEWA - pine

WOODEN DOORS

WOODEN DOORS

PRODUCT SPECIFICATION

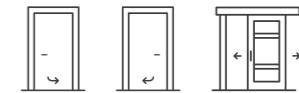

GENEWA DOOR.PN.80P, ROUGH



GENEWA DOOR.2S.80P, ROUGH

GENEWA DOOR.6S.80P, ROUGH

DOOR STRUCTURE

Frame and panel of the door made of glued Polish pine, veneered with natural pine veneer.

STANDARD EQUIPMENT

- + Door with rebate
- + Glazed versions: 4 mm milky tempered glass
- + Hinges in silver color
- + Locks:
 - full door: insert lock
 - door 2 glasses: bathroom lock
 - door 6 glasses: simple lock

FRAMES, MASKING STRIPS AND ACCESSORIES*

- + Adjustable knotless frame
- + Fixed knotless frame
- + Knotless masking strip
- + Wall-mounted, sliding, masking systems

* door frames, masking strips and accessories - details on pages 74-86

AVAILABLE DIMENSIONS

60, 70, 80, 90

AVAILABLE TYPES OF FINISHING

Rough

ADDITIONAL OPTIONS

Lack

APPROVALS

The door complies with the current building standard - Technical Approval No. AT-15-6912/2016.

GLAZING - TEMPERED MILK GLASS



NORMANDIA - pine



NORMANDIA DOOR.PN.80P, ROUGH

WOODEN DOORS



NORMANDIA DOOR.45.80P, ROUGH

NORMANDIA DOOR.65.80P, ROUGH

POSSIBLE FINISHING

OILING:

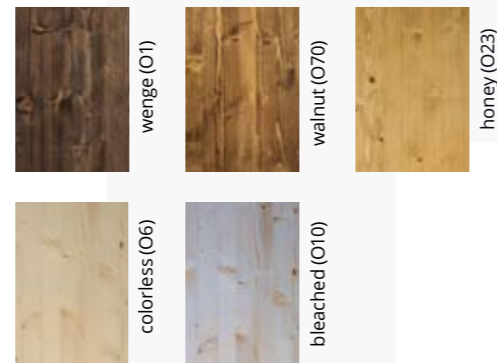

OLD TOWN:

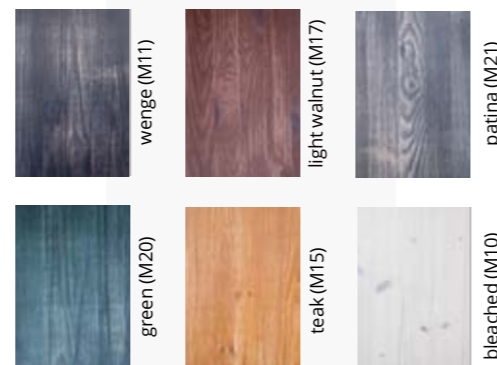

WOODEN DOORS

PRODUCT SPECIFICATION

DOOR STRUCTURE

Frame and panel of the door made of glued Scandinavian pine.

STANDARD EQUIPMENT

- + Door with rebate
- + Glazed versions: 4 mm milky tempered glass
- + Hinges in silver color
- + Locks:
 - full door: insert lock
 - door 4 glasses: bathroom lock
 - door 6 glasses: simple lock

FRAMES, MASKING STRIPS AND ACCESSORIES*

- + Adjustable knotted frame (simple/decorative)
- + Fixed knotted frame
- + Knotted masking strip (simple/decorative)
- + Wall-mounted, sliding, masking systems

* door frames, masking strips and accessories - details on pages 74-86

APPROVALS

The door complies with the current building standard - Technical Approval No. AT-15-6912/2016.

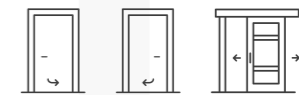

AVAILABLE DIMENSIONS

60, 70, 80, 90, 100*

AVAILABLE TYPES OF FINISHING

- + Rough
- + Oiled
- + Old Town (old-looking)

ADDITIONAL OPTIONS*

- + Preparation of the door for the sliding system (non-rebated door, without hinges and lock)
- + Ventilation undercut or ventilation sleeves (not applicable to sliding system doors)
- + Change of the lock

* Additional options - see pages 84-87 for details.

GLAZING - TEMPERED MILK GLASS



BERGEN - pine



BERGEN DOOR, PN.80P, ROUGH

WOODEN DOORS



BERGEN DOOR.25.80P, ROUGH

BERGEN DOOR.45.80P, ROUGH

POSSIBLE FINISHING

OILING:

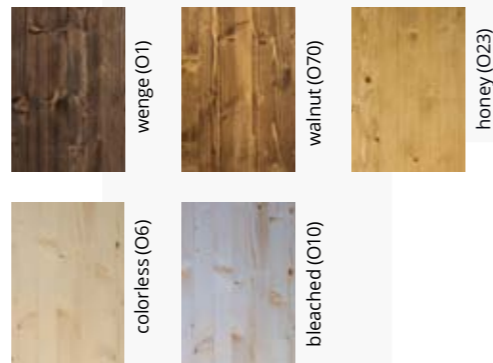

OLD TOWN:

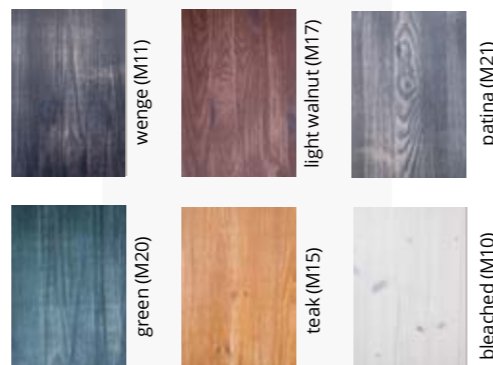

WOODEN DOORS

PRODUCT SPECIFICATION

DOOR STRUCTURE

Frame and panel of the door made of glued Scandinavian pine.

STANDARD EQUIPMENT

- + Door with rebate
- + Glazed versions: 4 mm milky tempered glass
- + Hinges in silver color
- + Locks:
 - full door: insert lock
 - door 2 glasses: bathroom lock
 - door 4 glasses: simple lock

FRAMES, MASKING STRIPS AND ACCESSORIES*

- + Adjustable knotted frame (simple/decorative)
- + Fixed knotted frame
- + Knotted masking strip (simple/decorative)
- + Wall-mounted, sliding, masking systems

* door frames, masking strips and accessories - details on pages 74-86

APPROVALS

The door complies with the current building standard - Technical Approval No. AT-15-6912/2016.

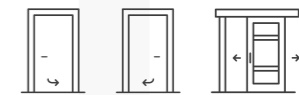

AVAILABLE DIMENSIONS

60, 70, 80, 90, 100*

AVAILABLE TYPES OF FINISHING

- + Rough
- + Oiled
- + Old Town (old-looking)

ADDITIONAL OPTIONS*

- + Preparation of the door for the sliding system (non-rebated door, without hinges and lock)
- + Ventilation undercut or ventilation sleeves (not applicable to sliding system doors)
- + Change of the lock

* Additional options - see pages 84-87 for details.

GLAZING - TEMPERED MILK GLASS



CZAPLA - pine



KŘÍDLO CZAPLA.PN.80P, ROUGH

WOODEN DOORS



KŘÍDLO CZAPLA.4S.80P, ROUGH

KŘÍDLO CZAPLA.6S.80P, ROUGH

POSSIBLE FINISHING

OILING:

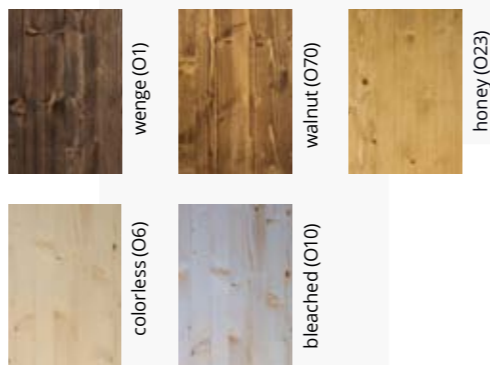

OLD TOWN:

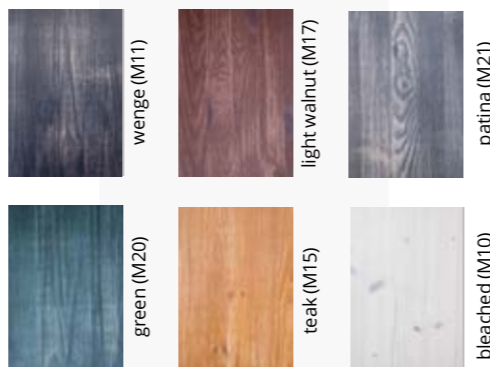

WOODEN DOORS

PRODUCT SPECIFICATION

DOOR STRUCTURE

Frame and panel of the door made of glued Scandinavian pine.

STANDARD EQUIPMENT

- + Door with rebate
- + Glazed versions: 4 mm milky tempered glass
- + Hinges in silver color
- + Locks:
 - full door: insert lock
 - door 4 glasses: bathroom lock
 - door 6 glasses: simple lock

FRAMES, MASKING STRIPS AND ACCESSORIES*

- + Adjustable knotted frame (simple/decorative)
- + Fixed knotted frame
- + Knotted masking strip (simple/decorative)
- + Wall-mounted, sliding, masking systems

* door frames, masking strips and accessories - details on pages 74-86

APPROVALS

The door complies with the current building standard - Technical Approval No. AT-15-6912/2016.

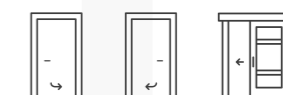

AVAILABLE DIMENSIONS

60, 70, 80, 90, 100*

AVAILABLE TYPES OF FINISHING

- + Rough
- + Oiled
- + Old Town (old-looking)

ADDITIONAL OPTIONS*

- + Preparation of the door for the sliding system (non-rebated door, without hinges and lock)
- + Ventilation undercut or ventilation sleeves (not applicable to sliding system doors)
- + Change of the lock

* Additional options - see pages 84-87 for details.

GLAZING - TEMPERED MILK GLASS



ILAWA - pine



ILAWA DOOR.PN.80P, ROUGH

WOODEN DOORS



ILAWA DOOR.4S.80P, ROUGH

ILAWA DOOR.6S.80P, ROUGH

POSSIBLE FINISHING

OILING:

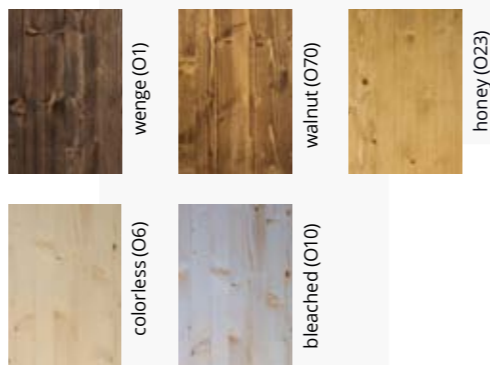

OLD TOWN:

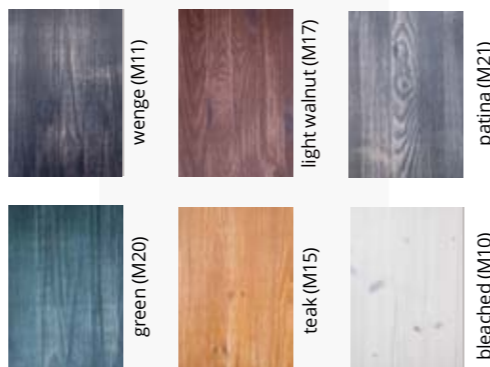

WOODEN DOORS

PRODUCT SPECIFICATION

DOOR STRUCTURE

Frame and panel of the door made of glued Scandinavian pine.

STANDARD EQUIPMENT

- + Door with rebate
- + Glazed versions: 4 mm milky tempered glass
- + Hinges in silver color
- + Locks:
 - full door: insert lock
 - door 4 glasses: bathroom lock
 - door 6 glasses: simple lock

FRAMES, MASKING STRIPS AND ACCESSORIES*

- + Adjustable knotted frame (simple/decorative)
- + Fixed knotted frame
- + Knotted masking strip (simple/decorative)
- + Wall-mounted, sliding, masking systems

* door frames, masking strips and accessories - details on pages 74-86

APPROVALS

The door complies with the current building standard - Technical Approval No. AT-15-6912/2016.

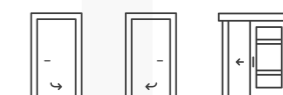

AVAILABLE DIMENSIONS

60, 70, 80, 90, 100*

AVAILABLE TYPES OF FINISHING

- + Rough
- + Oiled
- + Old Town (old-looking)

ADDITIONAL OPTIONS*

- + Preparation of the door for the sliding system (non-rebated door, without hinges and lock)
- + Ventilation undercut or ventilation sleeves (not applicable to sliding system doors)
- + Change of the lock

* Additional options - see pages 84-87 for details.

GLAZING - TEMPERED MILK GLASS



LIZBONA - pine



LIZBONA DOOR.PN.80P, ROUGH

WOODEN DOORS



LIZBONA DOOR.1S.80P, ROUGH

LIZBONA DOOR.4S.80P, ROUGH

POSSIBLE FINISHING

OILING:

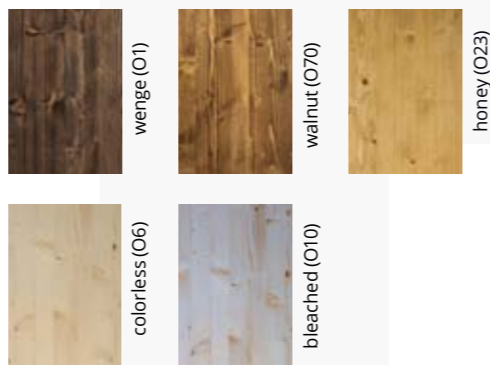

OLD TOWN:

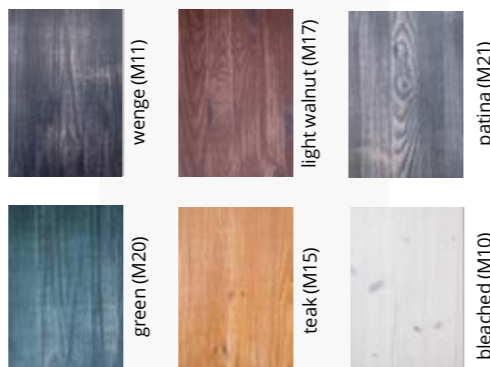

WOODEN DOORS

PRODUCT SPECIFICATION

DOOR STRUCTURE

Frame and panel of the door made of glued Scandinavian pine.

STANDARD EQUIPMENT

- + Door with rebate
- + Glazed versions: 4 mm milky tempered glass
- + Hinges in silver color
- + Locks:
 - full door: insert lock
 - Door 1 glass: bathroom lock
 - door 4 glasses: simple lock

FRAMES, MASKING STRIPS AND ACCESSORIES*

- + Adjustable knotted frame (simple/decorative)
- + Fixed knotted frame
- + Knotted masking strip (simple/decorative)
- + Wall-mounted, sliding, masking systems

* door frames, masking strips and accessories - details on pages 74-86

APPROVALS

The door complies with the current building standard - Technical Approval No. AT-15-6912/2016.

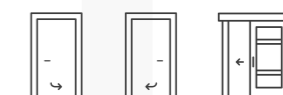

AVAILABLE DIMENSIONS

60, 70, 80, 90, 100*

AVAILABLE TYPES OF FINISHING

- + Rough
- + Oiled
- + Old Town (old-looking)

ADDITIONAL OPTIONS*

- + Preparation of the door for the sliding system (non-rebated door, without hinges and lock)
- + Ventilation undercut or ventilation sleeves (not applicable to sliding system doors)
- + Change of the lock

* Additional options - see pages 84-87 for details.

GLAZING - TEMPERED MILK GLASS



LONDYN - pine



LONDYN DOOR.PN.80P, ROUGH

WOODEN DOORS



LONDYN DOOR.4S.80P, ROUGH

LONDYN DOOR.6S.80P, ROUGH

WOODEN DOORS

PRODUCT SPECIFICATION

DOOR STRUCTURE

Frame and panel of the door made of glued Scandinavian pine.

STANDARD EQUIPMENT

- + Door with rebate
- + Glazed versions: 4 mm milky tempered glass
- + Hinges in silver color
- + Locks:
 - full door: insert lock
 - door 4 glasses: bathroom lock
 - door 6 glasses: simple lock

FRAMES, MASKING STRIPS AND ACCESSORIES*

- + Adjustable knotted frame (simple/decorative)
- + Fixed knotted frame
- + Knotted masking strip (simple/decorative)
- + Wall-mounted, sliding, masking systems

* door frames, masking strips and accessories - details on pages 74-86

APPROVALS

The door complies with the current building standard - Technical Approval No. AT-15-6912/2016.



AVAILABLE DIMENSIONS

60, 70, 80, 90, 100*

AVAILABLE TYPES OF FINISHING

- + Rough
- + Oiled
- + Old Town (old-looking)

ADDITIONAL OPTIONS*

- + Preparation of the door for the sliding system (non-rebated door, without hinges and lock)
- + Ventilation undercut or ventilation sleeves (not applicable to sliding system doors)
- + Change of the lock

* Additional options - see pages 84-87 for details.

GLAZING - TEMPERED MILK GLASS



POSSIBLE FINISHING

OILING:

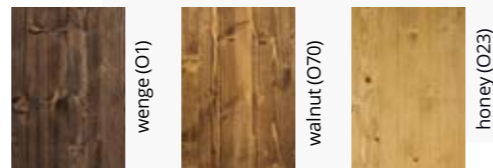

OLD TOWN:

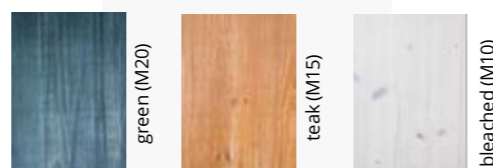

LUGANO - pine



LUGANO DOOR.PN.80P, ROUGH

WOODEN DOORS



LUGANO DOOR.1S.80P, ROUGH

LUGANO DOOR.6S.80P, ROUGH

POSSIBLE FINISHING

OILING:

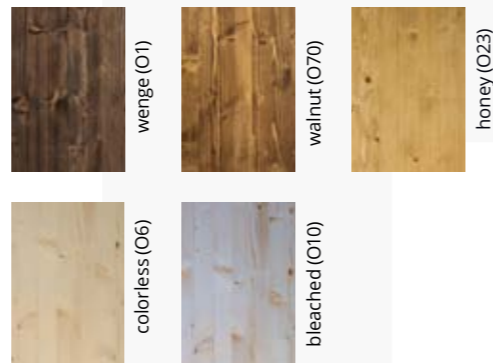

OLD TOWN:

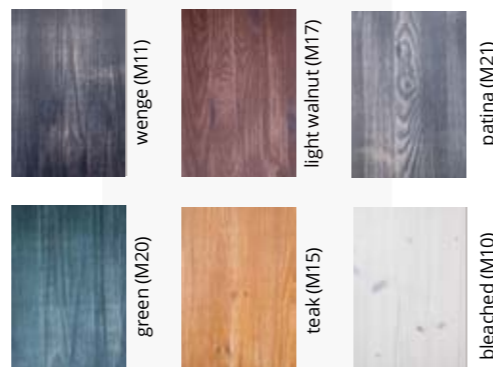

WOODEN DOORS

PRODUCT SPECIFICATION

DOOR STRUCTURE

Frame and panel of the door made of glued Scandinavian pine.

STANDARD EQUIPMENT

- + Door with rebate
- + Glazed versions: 4 mm milky tempered glass
- + Hinges in silver color
- + Locks:
 - full door: insert lock
 - Door 1 glass: bathroom lock
 - door 6 glasses: simple lock

FRAMES, MASKING STRIPS AND ACCESSORIES*

- + Adjustable knotted frame (simple/decorative)
- + Fixed knotted frame
- + Knotted masking strip (simple/decorative)
- + Wall-mounted, sliding, masking systems

* door frames, masking strips and accessories - details on pages 74-86

APPROVALS

The door complies with the current building standard - Technical Approval No. AT-15-6912/2016.



AVAILABLE DIMENSIONS

60, 70, 80, 90, 100*

AVAILABLE TYPES OF FINISHING

- + Rough
- + Oiled
- + Old Town (old-looking)

ADDITIONAL OPTIONS*

- + Preparation of the door for the sliding system (non-rebated door, without hinges and lock)
- + Ventilation undercut or ventilation sleeves (not applicable to sliding system doors)
- + Change of the lock

* Additional options - see pages 84-87 for details.

GLAZING - TEMPERED MILK GLASS



VERONA - pine



VERONA DOOR .PN.80P, ROUGH

WOODEN DOORS



VERONA DOOR.1S.80P, ROUGH

VERONA DOOR.8S.80P, ROUGH

POSSIBLE FINISHING

OILING:

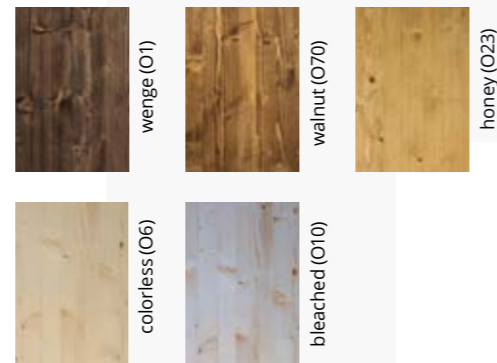

OLD TOWN:

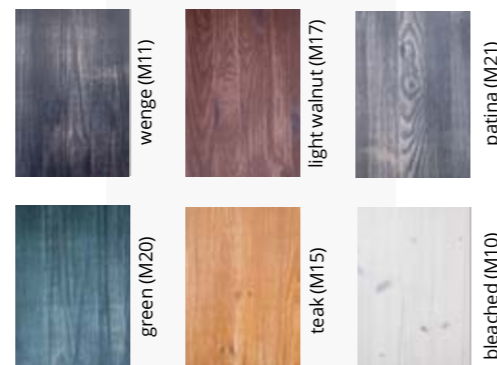

WOODEN DOORS

PRODUCT SPECIFICATION

DOOR STRUCTURE

Frame and panel of the door made of glued Scandinavian pine.

STANDARD EQUIPMENT

- + Door with rebate
- + Glazed versions: 4 mm milky tempered glass
- + Hinges in silver color
- + Locks:
 - full door: insert lock
 - Door 1 glass: bathroom lock
 - door 8 glasses: simple lock

FRAMES, MASKING STRIPS AND ACCESSORIES*

- + Adjustable knotted frame (simple/decorative)
- + Fixed knotted frame
- + Knotted masking strip (simple/decorative)
- + Wall-mounted, sliding, masking systems

* door frames, masking strips and accessories - details on pages 74-86

APPROVALS

The door complies with the current building standard - Technical Approval No. AT-15-6912/2016.



AVAILABLE DIMENSIONS

60, 70, 80, 90, 100*

AVAILABLE TYPES OF FINISHING

- + Rough
- + Oiled
- + Old Town (old-looking)

ADDITIONAL OPTIONS*

- + Preparation of the door for the sliding system (non-rebated door, without hinges and lock)
- + Ventilation undercut or ventilation sleeves (not applicable to sliding system doors)
- + Change of the lock

* Additional options - see pages 84-87 for details.

GLAZING - TEMPERED MILK GLASS



WOODEN DOORS

WOODEN DOORS

ISTRIA - pine

PRODUCT SPECIFICATION

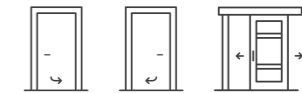

ISTRIA DOOR.PN.80P, ROUGH



ISTRIA DOOR.1S.80P, ROUGH



ISTRIA DOOR.2S.80P, ROUGH



ISTRIA DOOR.5S.80P, ROUGH

DOOR STRUCTURE

Frame and panel of the door made of glued Polish pine, veneered with natural pine veneer.

STANDARD EQUIPMENT

- + Door with rebate
- + Glazed versions: 4 mm milky tempered glass
- + Hinges in silver color
- + Locks:
 - full door: insert lock
 - křídlo 1, 2 skla: bathroom lock
 - door 5 glasses: key lock

FRAMES, MASKING STRIPS AND ACCESSORIES*

- + Adjustable knotless frame
- + Fixed knotless frame
- + Knotless masking strip
- + Wall-mounted, sliding, masking systems

* door frames, masking strips and accessories - details on pages 74-86

APPROVALS

The door complies with the current building standard - Technical Approval No. AT-15-6912/2016.

AVAILABLE DIMENSIONS

60, 70, 80, 90, 100*

AVAILABLE TYPES OF FINISHING

Rough

ADDITIONAL OPTIONS*

- + Preparation of the door for the sliding system (non-rebated door, without hinges and lock)
- + Ventilation undercut or ventilation sleeves (not applicable to sliding system doors)
- + Change of the lock

* Additional options - see pages 84-87 for details.

GLAZING - TEMPERED MILK GLASS



WOODEN DOORS

WOODEN DOORS

MANHATTAN - pine

PRODUCT SPECIFICATION

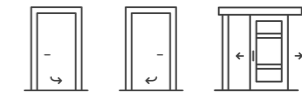

MANHATTAN DOOR.PN.80P, ROUGH



MANHATTAN DOOR.25.80P, ROUGH



MANHATTAN DOOR.65.80P, ROUGH

DOOR STRUCTURE

Frame and panel of the door made of glued Polish pine, veneered with natural pine veneer.

STANDARD EQUIPMENT

- + Door with rebate
- + Glazed versions: 4 mm milky tempered glass
- + Hinges in silver color
- + Locks:
 - full door: insert lock
 - door 2 glasses: bathroom lock
 - door 6 glasses: simple lock

FRAMES, MASKING STRIPS AND ACCESSORIES*

- + Adjustable knotless frame
- + Fixed knotless frame
- + Knotless masking strip
- + Wall-mounted, sliding, masking systems

* door frames, masking strips and accessories - details on pages 74-86

APPROVALS

The door complies with the current building standard - Technical Approval No. AT-15-6912/2016.

AVAILABLE DIMENSIONS

60, 70, 80, 90, 100*

AVAILABLE TYPES OF FINISHING

Rough

ADDITIONAL OPTIONS*

- + Preparation of the door for the sliding system (non-rebated door, without hinges and lock)
- + Ventilation undercut or ventilation sleeves (not applicable to sliding system doors)
- + Change of the lock

* Additional options - see pages 84-87 for details.

GLAZING - TEMPERED MILK GLASS



WOODEN DOORS

WOODEN DOORS

TRYPLET - pine

PRODUCT SPECIFICATION

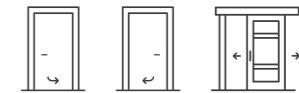

TRYPLET DOOR.PN.80P, ROUGH



TRYPLET DOOR.4S.80P, ROUGH



TRYPLET DOOR.6S.80P, ROUGH

DOOR STRUCTURE

Frame and panel of the door made of glued Polish pine, veneered with natural pine veneer.

STANDARD EQUIPMENT

- + Door with rebate
- + Glazed versions: 4 mm milky tempered glass
- + Hinges in silver color
- + Locks:
 - full door: insert lock
 - door 4 glasses: bathroom lock
 - Door 6 glasses: simple lock

FRAMES, MASKING STRIPS AND ACCESSORIES*

- + Adjustable knotless frame
- + Fixed knotless frame
- + Knotless masking strip
- + Wall-mounted, sliding, masking systems

* door frames, masking strips and accessories - details on pages 74-86

APPROVALS

The door complies with the current building standard - Technical Approval No. AT-15-6912/2016.

AVAILABLE DIMENSIONS

60, 70, 80, 90, 100*

AVAILABLE TYPES OF FINISHING

Rough

ADDITIONAL OPTIONS*

- + Preparation of the door for the sliding system (non-rebated door, without hinges and lock)
- + Ventilation undercut or ventilation sleeves (not applicable to sliding system doors)
- + Change of the lock

* Additional options - see pages 84-87 for details.

GLAZING - TEMPERED MILK GLASS



WOODEN DOORS

WOODEN DOORS

TURYN - pine

PRODUCT SPECIFICATION



TURYN DOOR.PN.80P, ROUGH



TURYN DOOR.4S.80P, ROUGH



TURYN DOOR.6S.80P, ROUGH

DOOR STRUCTURE

Frame and panel of the door made of glued Polish pine, veneered with natural pine veneer.

STANDARD EQUIPMENT

- + Door with rebate
- + Glazed versions: 4 mm milky tempered glass
- + Hinges in silver color
- + Locks:
 - full door: insert lock
 - door 4 glasses: bathroom lock
 - Door 6 glasses: simple lock

FRAMES, MASKING STRIPS AND ACCESSORIES*

- + Adjustable knotless frame
- + Fixed knotless frame
- + Knotless masking strip
- + Wall-mounted, sliding, masking systems

* door frames, masking strips and accessories - details on pages 74-86

APPROVALS

The door complies with the current building standard - Technical Approval No. AT-15-6912/2016.

AVAILABLE DIMENSIONS

60, 70, 80, 90, 100*

AVAILABLE TYPES OF FINISHING

Rough

ADDITIONAL OPTIONS*

- + Preparation of the door for the sliding system (non-rebated door, without hinges and lock)
- + Ventilation undercut or ventilation sleeves (not applicable to sliding system doors)
- + Change of the lock

* Additional options - see pages 84-87 for details.

GLAZING - TEMPERED MILK GLASS

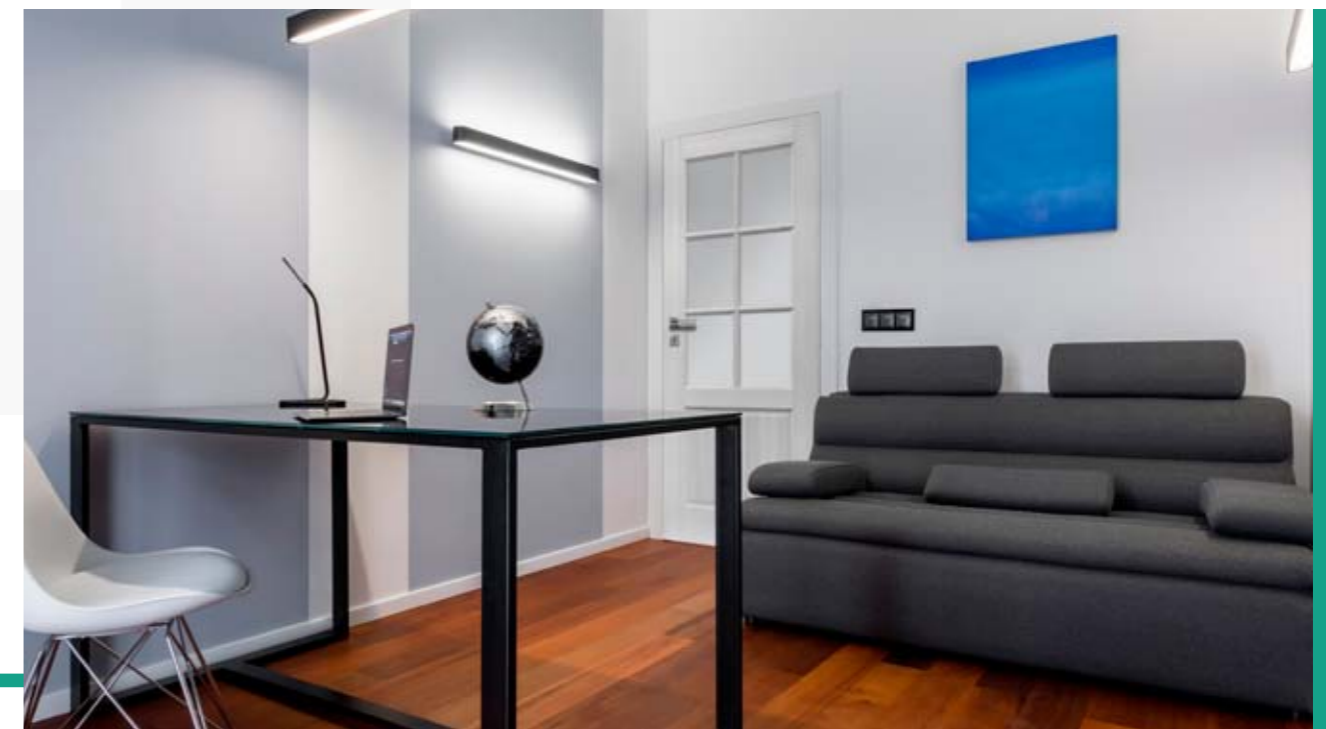

MARBELLA - pine



MARBELLA DOOR.PN.80P, ROUGH

WOODEN DOORS

WOODEN DOORS

PRODUCT SPECIFICATION

DOOR STRUCTURE

The frame of the door is made of glued Polish pine, panels made of MDF. All elements veneered with natural pine veneer.

STANDARD EQUIPMENT

- + Door with rebate
- + Glazed versions: 4 mm milky tempered glass
- + Hinges in silver color
- + Locks:
 - full door: insert lock
 - door 8 glasses: bathroom lock
 - doors 4, 6, 10 glasses: key lock

FRAMES, MASKING STRIPS AND ACCESSORIES*

- + Adjustable knotless frame
- + Fixed knotless frame
- + Knotless masking strip
- + Wall-mounted, sliding, masking systems

* door frames, masking strips and accessories - details on pages 74-86

APPROVALS

The door complies with the current building standard - Technical Approval No. AT-15-6912/2016.

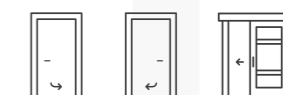

AVAILABLE DIMENSIONS

60, 70, 80, 90, 100*

AVAILABLE TYPES OF FINISHING

Rough

ADDITIONAL OPTIONS*

- + Preparation of the door for the sliding system (non-rebated door, without hinges and lock)
- + Ventilation undercut or ventilation sleeves (not applicable to sliding system doors)
- + Change of the lock

* Additional options - see pages 84-87 for details.

GLAZING - TEMPERED MILK GLASS



MARBELLA DOOR.10S.80P, ROUGH

MARBELLA DOOR.8S.80P, ROUGH



MARBELLA DOOR.6S.80P, ROUGH

MARBELLA DOOR.4S.80P, ROUGH

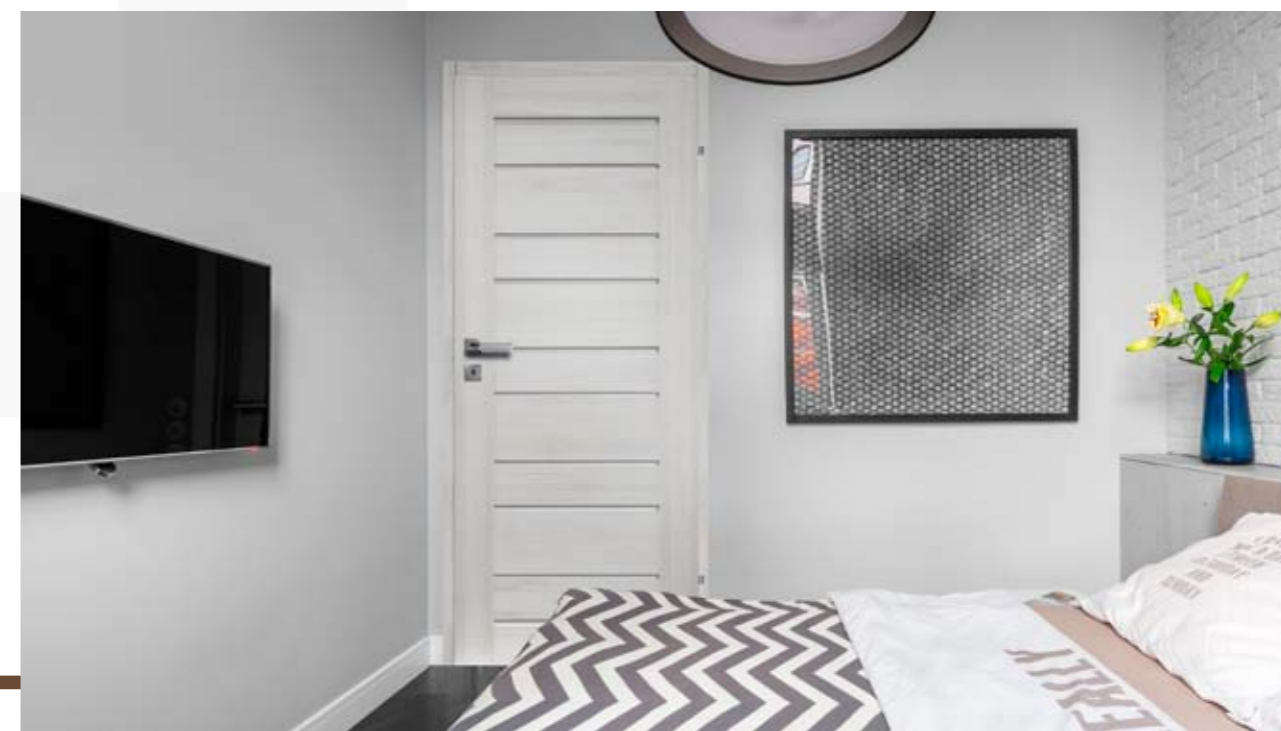

MALAGA - pine



MALAGA DOOR.PN.80P, ROUGH

WOODEN DOORS



MALAGA DOOR.25.80P, ROUGH

MALAGA DOOR.75.80P, ROUGH

WOODEN DOORS

PRODUCT SPECIFICATION

DOOR STRUCTURE

The frame of the door is made of glued Polish pine, panels made of MDF. All elements veneered with natural pine veneer.

STANDARD EQUIPMENT

- + Door with rebate
- + Glazed versions: 4 mm milky tempered glass
- + Hinges in silver color
- + Locks:
 - full door: insert lock
 - door 2 glasses: bathroom lock
 - door 7 glasses: key lock

FRAMES, MASKING STRIPS AND ACCESSORIES*

- + Adjustable knotless frame
- + Fixed knotless frame
- + Knotless masking strip

* door frames, masking strips and accessories - details on pages 74-86

APPROVALS

The door complies with the current building standard - Technical Approval No. AT-15-6912/2016.

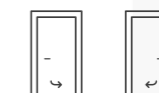

AVAILABLE DIMENSIONS

60, 70, 80, 90

AVAILABLE TYPES OF FINISHING

Rough

ADDITIONAL OPTIONS

- + Change of the lock

GLAZING - TEMPERED MILK GLASS



MILANO - pine



MILANO DOOR.PN.80P, ROUGH

WOODEN DOORS



MILANO DOOR.2S.80P, ROUGH

MILANO DOOR.8S.80P, ROUGH

WOODEN DOORS

PRODUCT SPECIFICATION

DOOR STRUCTURE

The frame of the door is made of glued Polish pine, panels made of MDF. All elements veneered with natural pine veneer.

STANDARD EQUIPMENT

- + Door with rebate
- + Glazed versions: 4 mm milky tempered glass
- + Hinges in silver color
- + Locks:
 - full door: insert lock
 - door 2 glasses: bathroom lock
 - door 8 glasses: key lock

FRAMES, MASKING STRIPS AND ACCESSORIES*

- + Adjustable knotless frame
- + Fixed knotless frame
- + Knotless masking strip
- + Wall-mounted, sliding, masking systems

* door frames, masking strips and accessories - details on pages 74-86

APPROVALS

The door complies with the current building standard - Technical Approval No. AT-15-6912/2016.

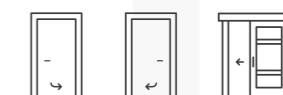

AVAILABLE DIMENSIONS

60, 70, 80, 90, 100*

AVAILABLE TYPES OF FINISHING

Rough

ADDITIONAL OPTIONS*

- + Preparation of the door for the sliding system (non-rebated door, without hinges and lock)
- + Ventilation undercut or ventilation sleeves (not applicable to sliding system doors)
- + Change of the lock

* Additional options - see pages 84-87 for details.

GLAZING - TEMPERED MILK GLASS



NEFRYT - pine



NEFRYT DOOR.PN.80P, ROUGH

WOODEN DOORS



NEFRYT DOOR.1S.80P, ROUGH

NEFRYT DOOR.4S.80P, ROUGH

WOODEN DOORS

PRODUCT SPECIFICATION

DOOR STRUCTURE

The frame of the door is made of glued Polish pine, panels made of MDF. All elements veneered with natural pine veneer.

STANDARD EQUIPMENT

- + Door with rebate
- + Glazed versions: 4 mm milky tempered glass
- + Hinges in silver color
- + Locks:
 - full door: insert lock
 - Door 1 glass: bathroom lock
 - door 4 glasses: key lock

FRAMES, MASKING STRIPS AND ACCESSORIES*

- + Adjustable knotless frame
- + Fixed knotless frame
- + Knotless masking strip
- + Wall-mounted, sliding, masking systems

* door frames, masking strips and accessories - details on pages 74-86

APPROVALS

The door complies with the current building standard - Technical Approval No. AT-15-6912/2016.



AVAILABLE DIMENSIONS

60, 70, 80, 90, 100*

AVAILABLE TYPES OF FINISHING

Rough

ADDITIONAL OPTIONS*

- + Preparation of the door for the sliding system (non-rebated door, without hinges and lock)
- + Ventilation undercut or ventilation sleeves (not applicable to sliding system doors)
- + Change of the lock

* Additional options - see pages 84-87 for details.

GLAZING - TEMPERED MILK GLASS



ROMA - pine



ROMA DOOR.PN.80P, ROUGH

WOODEN DOORS



ROMA DOOR.2S.80P, ROUGH

ROMA DOOR.7S.80P, ROUGH

WOODEN DOORS

PRODUCT SPECIFICATION

DOOR STRUCTURE

The frame of the door is made of glued Polish pine, panels made of MDF. All elements veneered with natural pine veneer.

STANDARD EQUIPMENT

- + Door with rebate
- + Glazed versions: 4 mm milky tempered glass
- + Hinges in silver color
- + Locks:
 - full door: insert lock
 - door 2 glasses: bathroom lock
 - door 7 glasses: key lock

FRAMES, MASKING STRIPS AND ACCESSORIES*

- + Adjustable knotless frame
- + Fixed knotless frame
- + Knotless masking strip
- + Wall-mounted, sliding, masking systems

* door frames, masking strips and accessories - details on pages 74-86

APPROVALS

The door complies with the current building standard - Technical Approval No. AT-15-6912/2016.

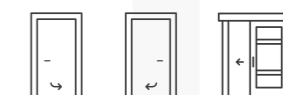

AVAILABLE DIMENSIONS

60, 70, 80, 90, 100*

AVAILABLE TYPES OF FINISHING

Rough

ADDITIONAL OPTIONS*

- + Preparation of the door for the sliding system (non-rebated door, without hinges and lock)
- + Ventilation undercut or ventilation sleeves (not applicable to sliding system doors)
- + Change of the lock

* Additional options - see pages 84-87 for details.

GLAZING - TEMPERED MILK GLASS

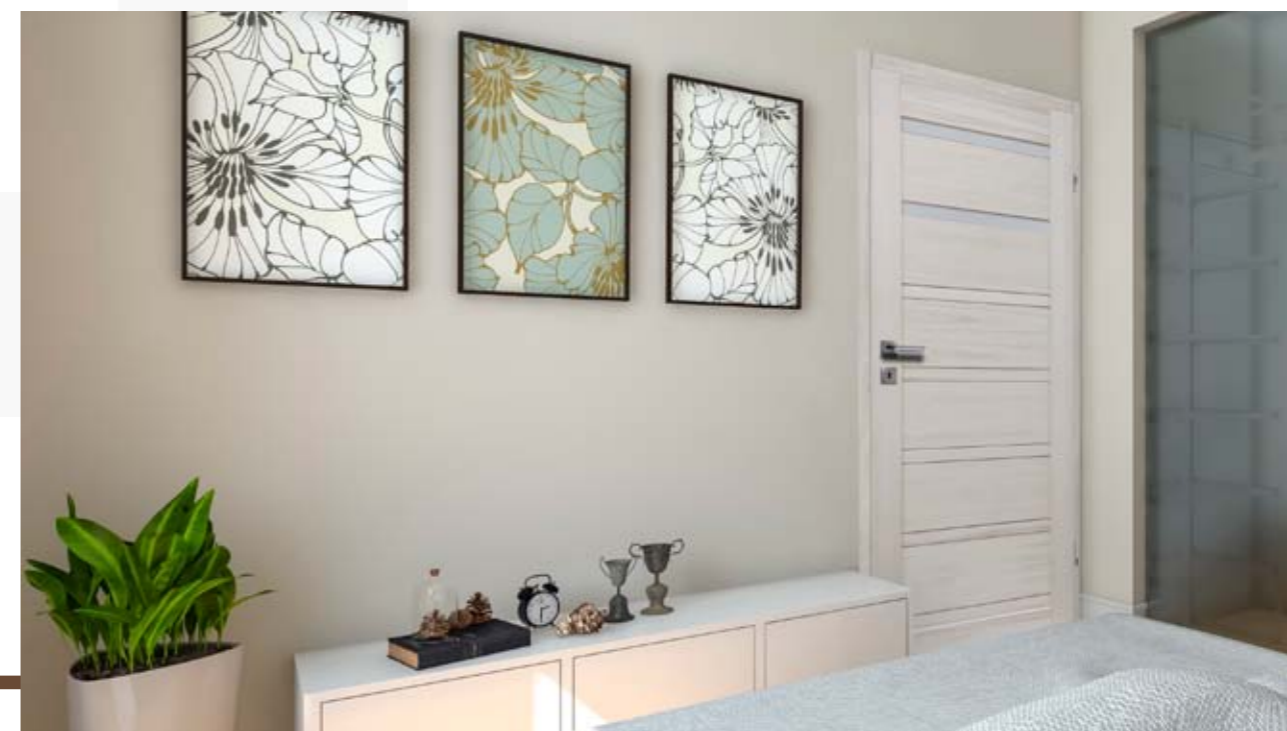

TOSSA - pine



TOSSA DOOR.PN.80P, ROUGH

WOODEN DOORS



TOSSA DOOR.15.80P, ROUGH

TOSSA DOOR.25.80P, ROUGH



TOSSA DOOR.35.80P, ROUGH

TOSSA DOOR.45.80P, ROUGH



TOSSA DOOR.55.80P, ROUGH

WOODEN DOORS

PRODUCT SPECIFICATION

DOOR STRUCTURE

The frame of the door is made of glued Polish pine, panels made of MDF. All elements veneered with natural pine veneer.

STANDARD EQUIPMENT

- + Door with rebate
- + Glazed versions: 4 mm milky tempered glass
- + Hinges in silver color
- + Locks:
 - full door: insert lock
 - doors 1, 2 glasses: bathroom lock
 - doors 3, 4, 5 glasses: key lock

FRAMES, MASKING STRIPS AND ACCESSORIES*

- + Adjustable knotless frame
- + Fixed knotless frame
- + Knotless masking strip
- + Wall-mounted, sliding, masking systems

* door frames, masking strips and accessories - details on pages 74-86

APPROVALS

The door complies with the current building standard - Technical Approval No. AT-15-6912/2016.

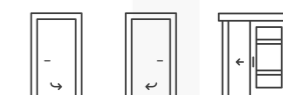

AVAILABLE DIMENSIONS

60, 70, 80, 90, 100*

AVAILABLE TYPES OF FINISHING

Rough

ADDITIONAL OPTIONS*

- + Preparation of the door for the sliding system (non-rebated door, without hinges and lock)
- + Ventilation undercut or ventilation sleeves (not applicable to sliding system doors)
- + Change of the lock

* Additional options - see pages 84-87 for details.

GLAZING - TEMPERED MILK GLASS



LOFT I - pine



LOFT I.PN.80L

WOODEN DOORS

WOODEN DOORS

PRODUCT SPECIFICATION

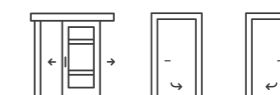

POSSIBLE FINISHING

OILING:

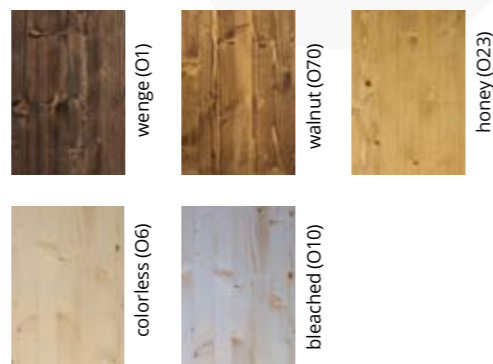

OLD TOWN:

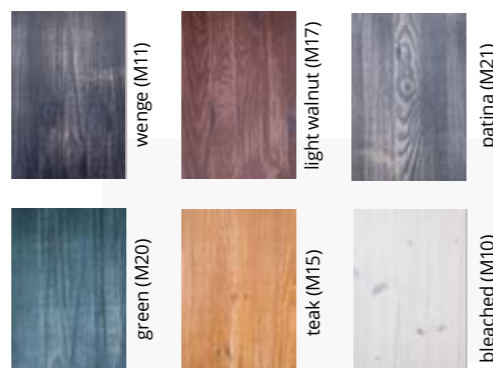

OLD TOWN + STRUCTURING:



DOOR STRUCTURE

Frame and panel of the door made of glued Scandinavian pine.

STANDARD EQUIPMENT

Non-rebated door without hinges and locks

FRAMES, MASKING STRIPS AND ACCESSORIES*

- + Sliding systems and accessories dedicated to the LOFT collection**
- + Adjustable knotted frame (simple/decorative)
- + Fixed knotted frame
- + Knotted masking strip (simple/decorative)
- + Wall-mounted, sliding, masking systems

* door frames, masking strips and accessories - details on pages 74-86

** sliding systems and accessories dedicated to the LOFT collection - see pages 64-71 for details.

AVAILABLE DIMENSIONS

60, 70, 80, 90

AVAILABLE TYPES OF FINISHING

- + Rough
- + Oiled
- + Old Town (old-looking)
- + Old Town structured (old-looking structured)

ADDITIONAL OPTIONS*

Made as a rebated with a lock and hinges

APPROVALS

The door complies with the current building standard - Technical Approval No. AT-15-6912/2016.



LOFT II - pine



LOFT II.PN.80L

WOODEN DOORS

POSSIBLE FINISHING

OILING:



OLD TOWN:

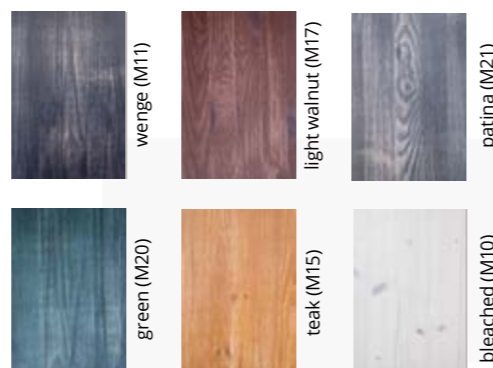

OLD TOWN + STRUCTURING:



WOODEN DOORS

PRODUCT SPECIFICATION

DOOR STRUCTURE

Frame and panel of the door made of glued Scandinavian pine.

STANDARD EQUIPMENT

Non-rebated door without hinges and locks

FRAMES, MASKING STRIPS AND ACCESSORIES*

- + Sliding systems and accessories dedicated to the LOFT collection**
- + Adjustable knotted frame (simple/decorative)
- + Fixed knotted frame
- + Knotted masking strip (simple/decorative)
- + Wall-mounted, sliding, masking systems

* door frames, masking strips and accessories - details on pages 74-86

** sliding systems and accessories dedicated to the LOFT collection - see pages 64-71 for details.

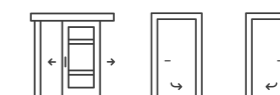

AVAILABLE DIMENSIONS

60, 70, 80, 90

AVAILABLE TYPES OF FINISHING

- + Rough
- + Oiled
- + Old Town (old-looking)
- + Old Town structured (old-looking structured)

ADDITIONAL OPTIONS*

Made as a rebated with a lock and hinges

APPROVALS

The door complies with the current building standard - Technical Approval No. AT-15-6912/2016.



LOFT X - pine



LOFT X.PN.80L

WOODEN DOORS

POSSIBLE FINISHING

OILING:



OLD TOWN:

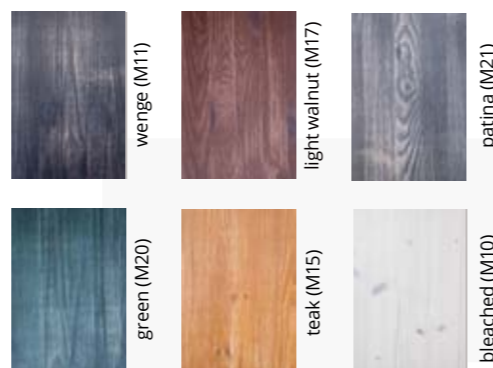

OLD TOWN + STRUCTURING:



WOODEN DOORS

PRODUCT SPECIFICATION

DOOR STRUCTURE

Frame and panel of the door made of glued Scandinavian pine.

STANDARD EQUIPMENT

Non-rebated door without hinges and locks

FRAMES, MASKING STRIPS AND ACCESSORIES*

- + Sliding systems and accessories dedicated to the LOFT collection**
- + Adjustable knotted frame (simple/decorative)
- + Fixed knotted frame
- + Knotted masking strip (simple/decorative)
- + Wall-mounted, sliding, masking systems

* door frames, masking strips and accessories - details on pages 74-86

** sliding systems and accessories dedicated to the LOFT collection - see pages 64-71 for details.

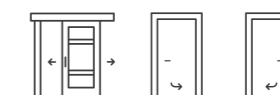

AVAILABLE DIMENSIONS

60, 70, 80, 90

AVAILABLE TYPES OF FINISHING

- + Rough
- + Oiled
- + Old Town (old-looking)
- + Old Town structured (old-looking structured)

ADDITIONAL OPTIONS*

Made as a rebated with a lock and hinges

APPROVALS

The door complies with the current building standard - Technical Approval No. AT-15-6912/2016.



LOFT Z - pine



LOFT Z.PN.80L

WOODEN DOORS

POSSIBLE FINISHING

OILING:



OLD TOWN:

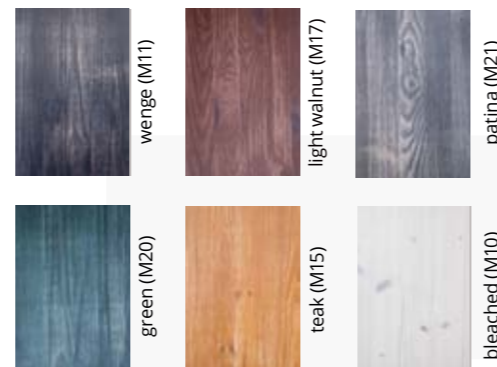

OLD TOWN + STRUCTURING:



WOODEN DOORS

PRODUCT SPECIFICATION

DOOR STRUCTURE

Frame and panel of the door made of glued Scandinavian pine.

STANDARD EQUIPMENT

Non-rebated door without hinges and locks

FRAMES, MASKING STRIPS AND ACCESSORIES*

- + Sliding systems and accessories dedicated to the LOFT collection**
- + Adjustable knotted frame (simple/decorative)
- + Fixed knotted frame
- + Knotted masking strip (simple/decorative)
- + Wall-mounted, sliding, masking systems

* door frames, masking strips and accessories - details on pages 74-86

** sliding systems and accessories dedicated to the LOFT collection - see pages 64-71 for details.

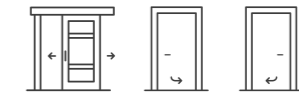

AVAILABLE DIMENSIONS

60, 70, 80, 90

AVAILABLE TYPES OF FINISHING

- + Rough
- + Oiled
- + Old Town (old-looking)
- + Old Town structured (old-looking structured)

ADDITIONAL OPTIONS*

Made as a rebated with a lock and hinges

APPROVALS

The door complies with the current building standard - Technical Approval No. AT-15-6912/2016.



LOFT XI - pine



LOFT XI.PN.80L

WOODEN DOORS

POSSIBLE FINISHING

OILING:



OLD TOWN:

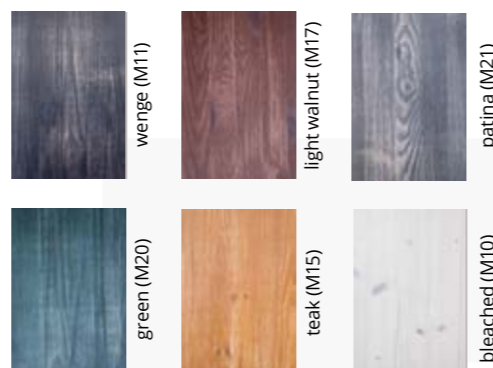

OLD TOWN + STRUCTURING:



WOODEN DOORS

PRODUCT SPECIFICATION

DOOR STRUCTURE

Frame and panel of the door made of glued Scandinavian pine.

STANDARD EQUIPMENT

Non-rebated door without hinges and locks

FRAMES, MASKING STRIPS AND ACCESSORIES*

- + Sliding systems and accessories dedicated to the LOFT collection**
- + Adjustable knotted frame (simple/decorative)
- + Fixed knotted frame
- + Knotted masking strip (simple/decorative)
- + Wall-mounted, sliding, masking systems

* door frames, masking strips and accessories - details on pages 74-86

** sliding systems and accessories dedicated to the LOFT collection - see pages 64-71 for details.

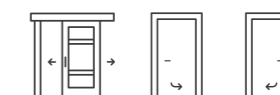

AVAILABLE DIMENSIONS

60, 70, 80, 90

AVAILABLE TYPES OF FINISHING

- + Rough
- + Oiled
- + Old Town (old-looking)
- + Old Town structured (old-looking structured)

ADDITIONAL OPTIONS*

Made as a rebated with a lock and hinges

APPROVALS

The door complies with the current building standard - Technical Approval No. AT-15-6912/2016.



LOFT XX - pine



LOFT XX.PN.80L

WOODEN DOORS

POSSIBLE FINISHING

OILING:



OLD TOWN:

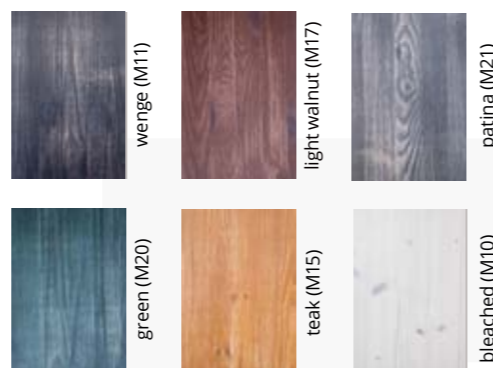

OLD TOWN + STRUCTURING:



WOODEN DOORS

PRODUCT SPECIFICATION

DOOR STRUCTURE

Frame and panel of the door made of glued Scandinavian pine.

STANDARD EQUIPMENT

Non-rebated door without hinges and locks

FRAMES, MASKING STRIPS AND ACCESSORIES*

- + Sliding systems and accessories dedicated to the LOFT collection**
- + Adjustable knotted frame (simple/decorative)
- + Fixed knotted frame
- + Knotted masking strip (simple/decorative)
- + Wall-mounted, sliding, masking systems

* door frames, masking strips and accessories - details on pages 74-86

** sliding systems and accessories dedicated to the LOFT collection - see pages 64-71 for details.

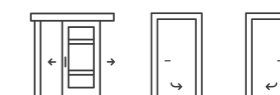

AVAILABLE DIMENSIONS

60, 70, 80, 90

AVAILABLE TYPES OF FINISHING

- + Rough
- + Oiled
- + Old Town (old-looking)
- + Old Town structured (old-looking structured)

ADDITIONAL OPTIONS*

Made as a rebated with a lock and hinges

APPROVALS

The door complies with the current building standard - Technical Approval No. AT-15-6912/2016.



LOFT OX - pine



LOFT OX.1S.80L

WOODEN DOORS

POSSIBLE FINISHING

OILING:

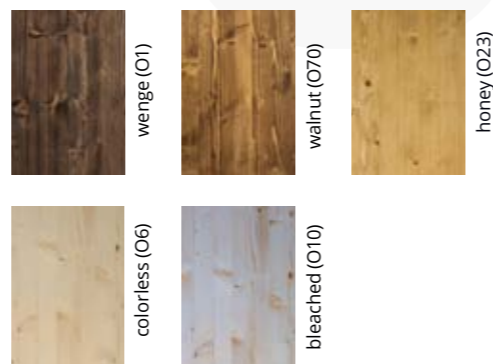

OLD TOWN:

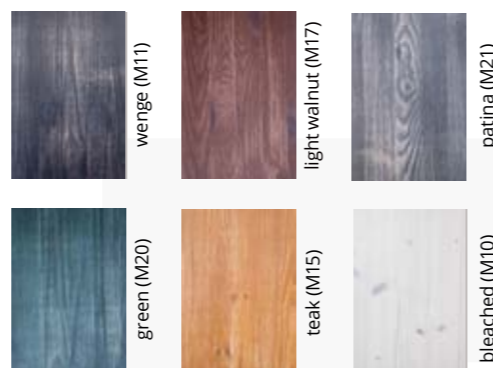

OLD TOWN + STRUCTURING:



WOODEN DOORS

PRODUCT SPECIFICATION

DOOR STRUCTURE

Frame and panel of the door made of glued Scandinavian pine.

STANDARD EQUIPMENT

- + Non-rebated door without hinges and locks
- + 4 mm milk glass, tempered

AVAILABLE TYPES OF FINISHING

- + Rough
- + Oiled
- + Old Town (old-looking)
- + Old Town structured (old-looking structured)

ADDITIONAL OPTIONS*

Made as a rebated with a lock and hinges

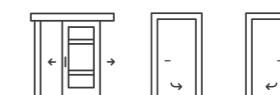

AVAILABLE DIMENSIONS

60, 70, 80, 90

APPROVALS

The door complies with the current building standard - Technical Approval No. AT-15-6912/2016.

FRAMES, MASKING STRIPS AND ACCESSORIES*

- + Sliding systems and accessories dedicated to the LOFT collection**
- + Adjustable knotted frame (simple/decorative)
- + Fixed knotted frame
- + Knotted masking strip (simple/decorative)
- + Wall-mounted, sliding, masking systems

* door frames, masking strips and accessories - details on pages 74-86

** sliding systems and accessories dedicated to the LOFT collection - see pages 64-71 for details.





ACCESSORIES
RADDEX®

LOFT

SLIDING SYSTEM - REA



Z36094

PRODUCT DESCRIPTION

Sliding system adapted to the LOFT collection. Inspired by loft style arrangements, it underlines the fashionable character of the interior, while guaranteeing the comfort of use and quiet and smooth movement.

PRODUCT FEATURES

- + door leaf weight up to 100kg
- + door thickness 35-45 mm
- + length of the guide 2000 mm
- + coating colour black matt
- + easy assembly
- + quiet and smooth movement
- + 25-year guarantee

DIMENSIONS

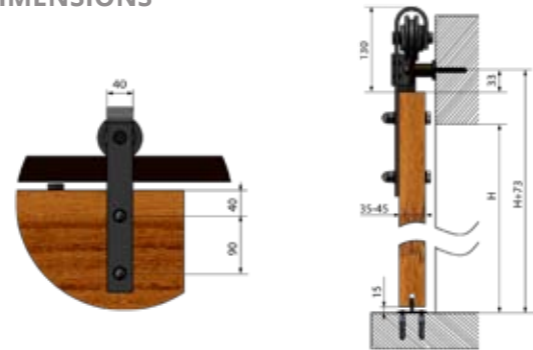

COMPOSITION OF THE KIT

- x1** GUIDEWIRE
- x2** TROLLEY
- x5** BUSH
- x1** SET OF FIXINGS
- x2** STOPWATCH
- x2** ANTI-GLARE SYSTEM
- x1** GUIDE



SLIDING SYSTEM - LUNA



Z36095

PRODUCT DESCRIPTION

Sliding system adapted to the LOFT collection. Inspired by loft style arrangements, it underlines the fashionable character of the interior, while guaranteeing the comfort of use and quiet and smooth movement.

PRODUCT FEATURES

- + door leaf weight up to 100kg
- + door thickness 35-45 mm
- + length of the guide 2000 mm
- + coating colour black matt
- + easy assembly
- + quiet and smooth movement
- + 25-year guarantee

DIMENSIONS

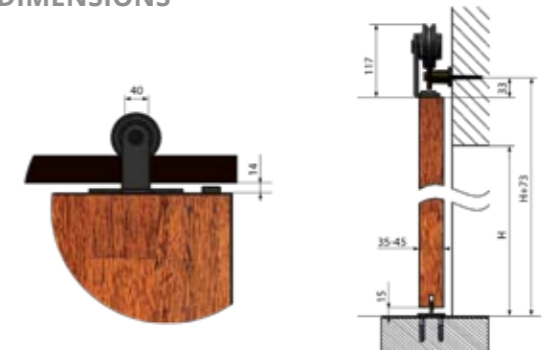

COMPOSITION OF THE KIT

- x1** GUIDEWIRE
- x2** TROLLEY
- x5** BUSH
- x1** SET OF FIXINGS
- x2** STOPWATCH
- x2** ANTI-GLARE SYSTEM
- x1** GUIDE



SLIDING SYSTEM - IZYDA



Z36096

PRODUCT DESCRIPTION

Sliding system adapted to the LOFT collection. Inspired by loft style arrangements, it underlines the fashionable character of the interior, while guaranteeing the comfort of use and quiet and smooth movement.

PRODUCT FEATURES

- + door leaf weight up to 100kg
- + door thickness 35-45 mm
- + length of the guide 2000 mm
- + coating colour black matt
- + easy assembly
- + quiet and smooth movement
- + 25-year guarantee

DIMENSIONS

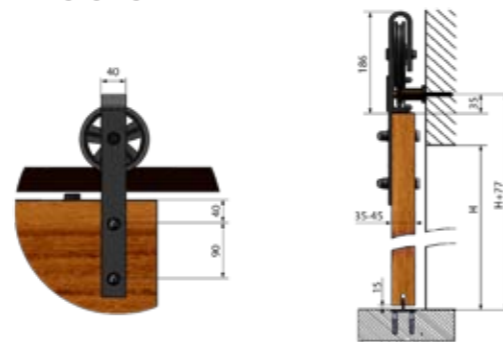

COMPOSITION OF THE KIT

- x1** GUIDEWIRE
- x2** TROLLEY
- x5** BUSH
- x1** SET OF FIXINGS
- x2** STOPWATCH
- x2** ANTI-GLARE SYSTEM
- x1** GUIDE



SLIDING SYSTEM - TEMIDA



Z36097

PRODUCT DESCRIPTION

Sliding system adapted to the LOFT collection. Inspired by loft style arrangements, it underlines the fashionable character of the interior, while guaranteeing the comfort of use and quiet and smooth movement.

PRODUCT FEATURES

- + door leaf weight up to 100kg
- + door thickness 35-45 mm
- + length of the guide 2000 mm
- + coating colour black matt
- + easy assembly
- + quiet and smooth movement
- + 25-year guarantee

DIMENSIONS

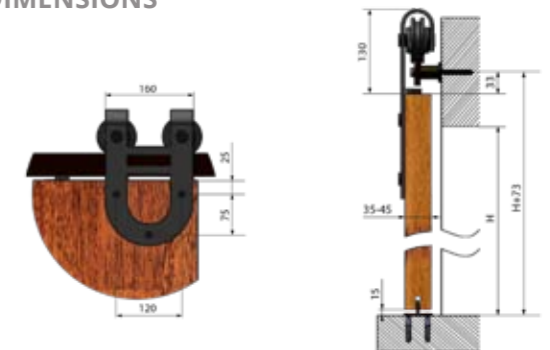

COMPOSITION OF THE KIT

- x1** GUIDEWIRE
- x2** TROLLEY
- x5** BUSH
- x1** SET OF FIXINGS
- x2** STOPWATCH
- x2** ANTI-GLARE SYSTEM
- x1** GUIDE



ADDITIONAL ACCESSORIES FOR A SLIDING SYSTEM



Z36147

Z36141

Z36146

DECORATIVE CORNER

An ornate, steel corner inspired by loft style arrangements underlines the designer character of the doors from the LOFT collection. Decorative corner is dedicated to the sliding system LUNA.

RECESSED HAND-RAIL

Recessed handle that can be mounted on both sides of the door for comfortable opening of the door.

DECORATIVE RIVET

Decorative rivet, made of steel is a stylish finish of the LOFT collection wings emphasizing the industrial character of the interior.

OTHER LOFT HAND-RAILS



Z36132

LOFT HAND-RAIL

Stylish, yet comfortable handle inspired by the latest trends in interior design.



Z36142

HAND-RAIL 2 PCS

A set of minimalistic, fitted to the aesthetics of the collection of handles for both sides mounting.



Z36144

ROUND HAND-RAIL STEEL

Round hand-rail made of polished steel.



Z36143

ROUND HAND-RAIL SATIN

Round handrail in satin.



ADDITIONAL ACCESSORIES FOR A SLIDING SYSTEM



**WALL BRACKET FOR THE
SECOND GUIDE**

Inspired by a modern loft style, the wall bracket for the second guide allows the installation of a double system.



**DESIGN LINE CLOSING
MECHANISM**

The set ensures smooth closing and stopping of the door thanks to a hidden closing mechanism.



**LOWER GUIDE MOUNTED
TO THE WALL**

Bottom guide covered with a mechanical damage resistant coating. Its installation does not require drilling holes in the floor.



INDEX	Product name
Z36121	DESIGN LINE closing mechanism set 2 pcs
Z36127	Wall bracket for the double DESIGN LINE system (REA, LUNA, TEMIDA), 1 pcs
Z36129	Metal bottom guide for sliding doors, side mounting, black matt, 1 pcs.
Z36132	Loft hand-rail 32x228 mm, black matt, 1 pcs.
Z36141	Recessed metal door handle, 53x203 mm, black matt, 1 pcs.
Z36142	Handrail 32x356 mm, matt black, 2 pcs.
Z36143	O58 satin round hand-rail, 1 pcs.
Z36144	Round polished steel hand-rail O58, 1 pcs.
Z36146	Metal decorative rivet, square 40x40 mm, black matt, 1 pcs.
Z36147	Decorative metal corner 75x75x25 mm, black matt, 1 pcs.



DOOR FRAMES
RADEX®

FIXED KNOTTED FRAME



FITS TO COLLECTION



PRODUCT DESCRIPTION

Fixed knotted frame made of pine wood. The set includes a gasket, two hinges and a catch plate.

TECHNICAL PARAMETERS

Dimension of the door frame: **90x40 mm**

Available widths: **60, 70, 80, 90, 100***

* Additional options - see page 78.



GASKET



HINGE



CATCH PLATE

CROSS-SECTION DRAWING

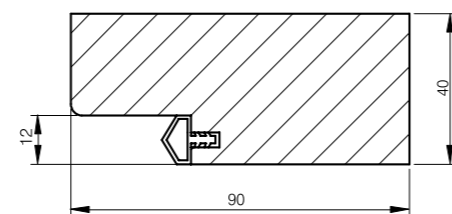

FIXED KNOTLESS FRAME



FITS TO COLLECTION



PRODUCT DESCRIPTION

Fixed knotless frame made of pine wood. The set includes a gasket, two hinges and a catch plate.

TECHNICAL PARAMETERS

Dimension of the door frame: **90x40 mm**

Available widths: **60, 70, 80, 90, 100***

* Additional options - see page 78.



GASKET



HINGE



CATCH PLATE

CROSS-SECTION DRAWING

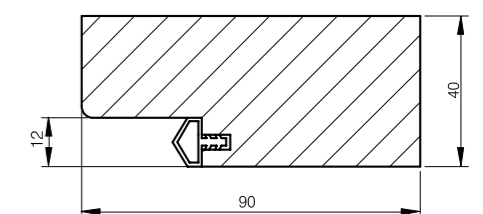

ADJUSTABLE KNOTTED FRAME

FITS TO COLLECTION



PRODUCT DESCRIPTION

Adjustable knotted frame made of pine wood. The set includes a gasket, two adjustable hinges and a catch plate.

TECHNICAL PARAMETERS

Available widths: **60, 70, 80, 90, 100***

Adjustment range: : **from 60 mm to 420 mm, every 20 mm**

* Additional options - see page 78.

SECTION



GASKET



ADJUSTABLE HINGE



CATCH PLATE

CROSS-SECTION DRAWING

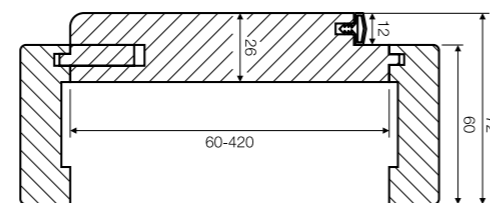

ADJUSTABLE KNOTLESS FRAME

FITS TO COLLECTION



PRODUCT DESCRIPTION

Adjustable frame made of pine wood. The set includes a gasket, two adjustable hinges and a catch plate.

TECHNICAL PARAMETERS

Available widths: **60, 70, 80, 90, 100***

Adjustment range: : **from 75 mm to 405 mm, every 15 mm**

* Additional options - see page 78.

SECTION



GASKET



ADJUSTABLE HINGE



CATCH PLATE

CROSS-SECTION DRAWING

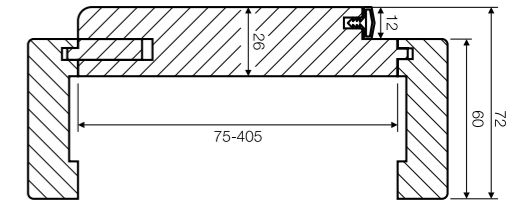

ADJUSTABLE KNOTTED DECORATIVE FRAME



FITS TO COLLECTION

- DIY
- CLASSIC
- LOFT

PRODUCT DESCRIPTION

Adjustable knotted frame with decorative profile made of pine wood. The set includes a gasket, two adjustable hinges and a catch plate.

TECHNICAL PARAMETERS

Available widths: **60, 70, 80, 90, 100***

Adjustment range: : **from 60 mm to 420 mm, every 20 mm**

* Additional options - see page 78.

SECTION



GASKET



ADJUSTABLE HINGE



CATCH PLATE

CROSS-SECTION DRAWING

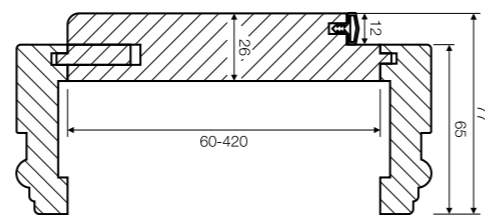

STRIPS AND QUARTER ROUNDS

Masking strips and quarter rounds are a perfect complement to the interior door arrangement. Each set contains 3 elements: 2 strips 2100 mm; 1 strip 1000 mm.

SIMPLE KNOTTED MASKING STRIP



DECORATIVE KNOTTED MASKING STRIP



KNOTLESS MASKING STRIP



QUARTER ROUNDS



POSSIBLE FINISHING

For fixed knotted frame, adjustable knotted frame, adjustable decorative knotted frame.

OILING:

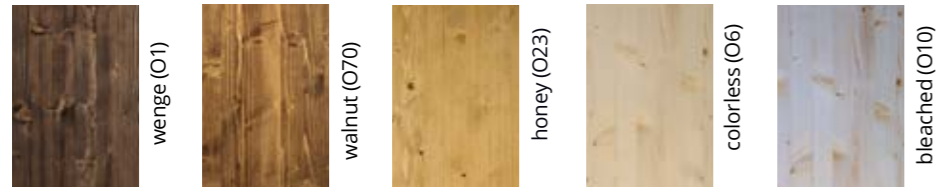

OLD TOWN:



FRAME WIDTH RANGE [mm]

For adjustable knotted frame, adjustable decorative knotted frame

OSU/R/60-80
OSU/R/80-100
OSU/R/100-120
OSU/R/120-140
OSU/R/140-160
OSU/R/160-180
OSU/R/180-200
OSU/R/200-220
OSU/R/220-240
OSU/R/240-260
OSU/R/260-280
OSU/R/280-300
OSU/R/300-320
OSU/R/320-340
OSU/R/340-360
OSU/R/360-380
OSU/R/380-400
OSU/R/400-420

For the adjustable knotless frame

OBU/R/75-90/
OBU/R/90-105/
OBU/R/105-120/
OBU/R/120-135/
OBU/R/135-150/
OBU/R/150-165/
OBU/R/165-180/
OBU/R/180-195/
OBU/R/195-210/
OBU/R/210-225/
OBU/R/225-240/
OBU/R/240-255/
OBU/R/255-270/
OBU/R/270-285/
OBU/R/285-300/
OBU/R/300-315/
OBU/R/315-330/
OBU/R/330-345/
OBU/R/345-360/
OBU/R/360-375/
OBU/R/375-390/
OBU/R/390-405/





ACCESSORIES

RADEX®

WALL-MOUNTED SYSTEM - RADEX



FITS TO COLLECTION

- DIY
- CLASSIC
- LOFT
- FOG
- PREMIUM

PRODUCT DESCRIPTION

The sliding system is dedicated to the door models of our production, marked with the sliding door symbol. It is ideal for rooms where space plays a key role. It allows the implementation of arrangements taking into account the limitations in the possibility of mounting standard doors. It is a convenient solution in everyday use, but it allows for a unique composition of interior design.

PRODUCT FEATURES

- + door leaf weight up to 80 kg
- + door thickness 40 mm
- + length of the guide 1500, 1800, 2000 mm
- + easy assembly
- + quiet and smooth movement
- + door stoppers in the set

ADDITIONAL ELEMENTS



GUARD TIMBER

COVET



BRASS
HAND-RAIL

NICKEL
HAND-RAIL

PATINE
HAND-RAIL

TECHNICAL DRAWING

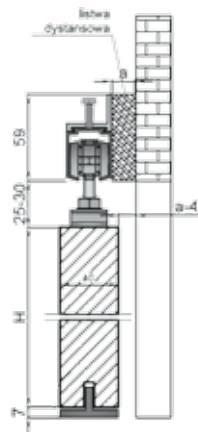

UNDERCUTS, VENTILATION TUBES AND LOCKS

WITHOUT UNDERCUT



WITH UNDERCUT



PLASTIC TUBES



INLET LOCK (ZW)



KEY LOCK (ZK)



BATHROOM LOCK (ZWC)



SIMPLE LOCK (ZO)



DIMENSIONS OF WOODEN DOORS

Rebate door (right and left), fixed door frame

Door types	Door dimensions (mm)							Required dimensions of door mounting openings (mm)	
	Total height of the door frame	Total width of the door frame	The width of the door clearance	Height of the transition	Height	Width	Thickness	Wo	So
	W1	S2	S1	W2	W3	S3	G		
60	2051	682	602	2011	2025	644	40	2061	702
70	2051	782	702	2011	2025	744	40	2061	802
80	2051	882	802	2011	2025	844	40	2061	902
90	2051	982	902	2011	2025	944	40	2061	1002
100	2051	1082	1002	2011	2025	1044	40	2061	1102

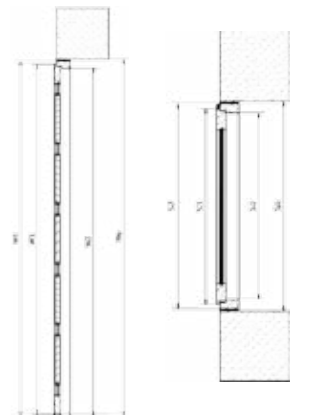

Rebate door (right and left), adjustable door frame

Door types	Door dimensions (mm)							Required dimensions of door mounting openings (mm)	
	Total height of the door frame	Total width of the door frame	The width of the door clearance	Height of the transition	Height	Width	Thickness	Wo	So
	W1	S2	S1	W2	W3	S3	G		
60	2083	746	602	2011	2025	644	40	2047	674
70	2083	846	702	2011	2025	744	40	2047	774
80	2083	946	802	2011	2025	844	40	2047	874
90	2083	1046	902	2011	2025	944	40	2047	974
100	2083	1146	1002	2011	2025	1044	40	2047	1074

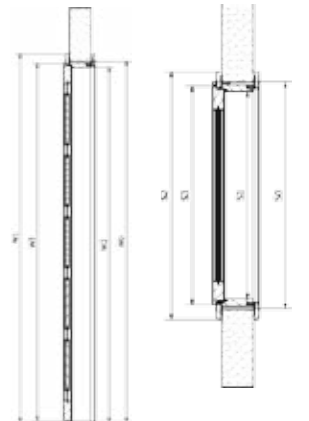

Sliding door, no door frames

Door types	Door dimensions (mm)								
					Height	Width	Thickness	Wo	So
	W1	S2	S1	W2	W3	S3	G		
60					2025	644	40		
70					2025	744	40		
80					2025	844	40		
90					2025	944	40		
100					2025	1044	40		

