



**Technical Manual.**  
Shower fittings. By SCHELL.



## Everything according to plan. With SCHELL.



kiwa



GL Systems Certification

SCHELL is a member of the initiative

**Blue Responsibility**

Nachhaltige Sanitärösungen

More information can be found at:  
[www.blue-responsibility.com](http://www.blue-responsibility.com)

**WELL** Public  
 Water Efficiency Label



Are you planning the shower area in a public, semi-public or commercial building? And would like to have specific information about the appropriate fittings? Then you are at the right place with SCHELL. As a leading specialist for sanitary rooms used by the public, we not only offer top-quality and multi-award-winning fitting technology »Made in Germany«. You also receive all necessary information in the technical brochure to assist your planning with SCHELL shower fittings. This starts with important information about standards and directives that must be adhered to, up to comprehensive details about products.

Also use our specification documents, at [www.ausschreiben.de](http://www.ausschreiben.de).

And if you have any queries about our products, don't hesitate to call us. We are more than happy to help.

Telephone +49 2761 892-0  
[www.schell.eu](http://www.schell.eu)

# Technical Manual.

## Shower fittings. By SCHELL.

<b>SCHELL inside</b>	<b>Page 4</b>
<b>Planning information worth knowing</b>	<b>Page 6</b>
<b>Thermal disinfection / Protection against legionella</b>	<b>Page 10</b>

---

### **Concealed solutions** **Page 14**

System overview	Page 16
Planning information	Page 18
Features and fields of application	Page 20
<i>Electronic actuation via cartridge solenoid valve</i>	<i>Page 25</i>
LINUS D-E-V/D-E-V ECO	Page 30
LINUS D-E-T/D-E-T ECO with thermostat	Page 32
Power supply, sensor electronic fittings	Page 36
LINUS D-C-M	Page 38
LINUS D-C-T / LINUS BASIC D-C-T with thermostat	Page 40
<i>Manual actuation via self-closing cartridge</i>	<i>Page 42</i>
LINUS BASIC D-SC-M	Page 46
LINUS D-SC-M / D-SC-V	Page 48
LINUS BASIC D-SC-T with thermostat	Page 50
LINUS D-SC-T with thermostat	Page 52
<i>Manual control using single-lever</i>	<i>Page 54</i>
LINUS D-EH-M	Page 56

---

### **Wall-mounted solutions** **Page 60**

<i>Manual actuation via self-closing cartridge</i>	
Shower panel LINUS DP-SC-M	Page 62
Shower panel LINUS DP-SC-V	Page 62
Shower panel LINUS DP-SC-T with thermostat	Page 63
<i>Electronic actuation via cartridge solenoid valve</i>	
Shower panel LINUS DP-C-T with thermostat	Page 64

---

### **Further information** **Page 66**



Concealed shower LINUS D-E-T



Wall-mounted shower panel LINUS DP-SC-T

# SCHELL *inside.*

SCHELL fittings belong in all places where robust, hygienic and resource-efficient solutions are needed, such as in public, semi-public and commercial sanitary rooms. Among others, our solutions can be found in the following locations all over the world:

- Schools
- Nurseries
- Hotels
- Gastronomy
- Hospitals
- Residential nursing homes
- Industry
- Administrative buildings
- Airports
- Railway stations
- Motorway service stations
- Leisure facilities
- Sports facilities
- Swimming pools



## **WC flush systems**

With their comprehensive range of water-saving and hygienic WC flush systems, SCHELL also fulfils the highest demands. These include flush valves for wall-mounted installation, concealed installation solutions and concealed cisterns. These can be controlled mechanically or electronically as you choose. All in all, ideal prerequisites for both simple and speedy retrofitting in renovation projects and for new-build installations. A perfect match – our mounting modules.



## **Washbasin fittings and wall-mounted draw-off fittings**

Water-saving, hygienic, robust, long-lasting and also good to view – this is what distinguishes the washbasin draw-off taps by SCHELL. Available in a wide range of different technical designs.



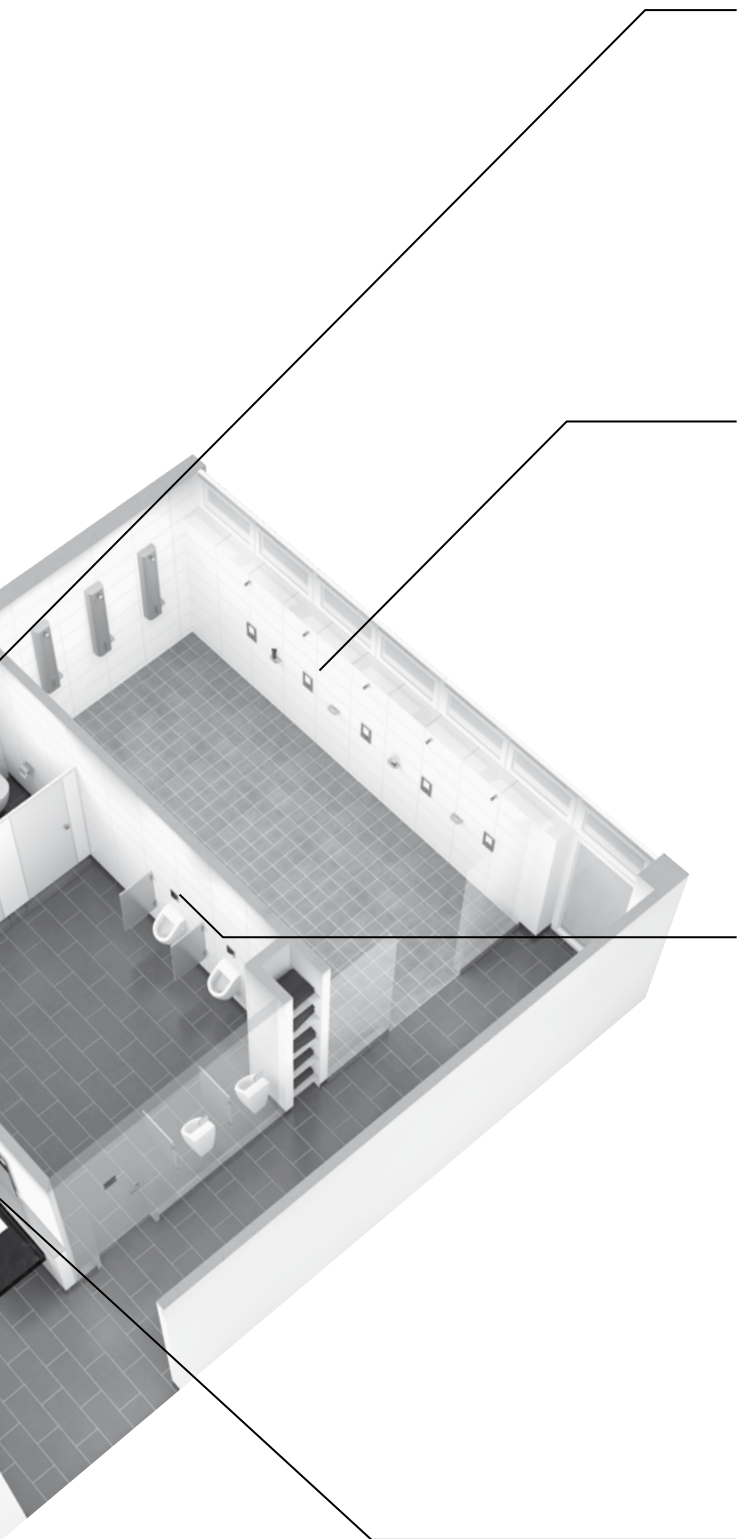

### Mounting modules

SCHELL offers a complete range of mounting modules. These are distinguished by: Models for dry and wet construction, compliance with DIN 4109 (noise protection in building construction) and a considerable number of innovative detailed solutions.



### Shower fittings/shower panels

Showers in public, semi-public and commercial sanitary rooms are in constant use. Irrespective of whether in a new or renovated building: The high-quality materials and well thought-out design contribute to durability, water-saving and trouble-free operation of our shower fittings and shower panels, also under these demanding conditions.



### Urinal Flush systems

They are in demand, as wall-mounted or concealed installations: water-saving and hygienic Urinal Flush systems by SCHELL. Available in mechanical and electronic designs, whereby, they are suitable for new constructions, or especially for easy and quick retrofitting in refurbishment projects. Urinal Flush systems by SCHELL: combined with our mounting modules, the perfect all-round solution.



### Angle valves

You can place high expectations on Europe's market leader for angle valves, including water-saving functions, exceptional quality, attractive design and an extensive range for all applications. These are available with an integrated backflow preventer or filter depending on requirements, and almost every model is classified in noise class I.





## Shower fittings by SCHELL. A good decision

### Uncompromising quality from specialists

Whether in schools, fitness centres or hotels – shower fittings in public, semi-public and commercial buildings must satisfy particular demands (in contrast to private sanitary rooms). As specialist for this field of application, SCHELL has attained an excellent name worldwide and, with LINUS, has developed a family of products for shower fittings that are convincing in all aspects.

### Robust materials

Historically, SCHELL places great value on the use of high-quality, robust materials. For example, all functional components are made from high-grade plastic. The body of the fittings are made from dezincification-resistant brass and, for our concealed solutions, are located well protected in concealed boxes. The associated front panels are made from brushed stainless steel or are also available in

chrome-plated brass. But that is not sufficient. The glass window for the electronic fittings are made from shatter-proof glass. In the area not visible, attachment of the fittings is carried out using the Torx spanner flats. Our shower panels also brave the hard daily use. They have a robust, anti-corrosive aluminium extruded section with high-quality, anodized surface that is easy to maintain.

### Water-saving technologies

For saving valuable and costly water, SCHELL provides various technical solutions. From single-lever fittings, self-closing fittings with hydraulically-operated cartridges or CVD Touch-technology, including Start-Stop function, up to sensor-based electronically-controlled solutions. Regardless of the version you select, the objective is to easily, economically and sparingly regulate the flow time and flow rate of the water.

### Stringent hygiene standards

Hygiene is of particular importance in public and semi-public shower areas. The smooth, rounded edges of the SCHELL fittings are easy to clean and offer minimum contact areas for accumulating dirt. The materials used for the components contacting water (DIN 19630 Part 6, and KTW and W270-recommendations) do not impair the quality of the drinking water. To protect against legionella, thermal disinfection can also be used for the thermostat fittings to prevent the spread of legionella, or disinfect the contaminated system. In accordance with the DVGW, Worksheet W551, a continuous flow of water at 70 °C for 5 minutes eradicates dangerous legionella bacteria.



In order, e.g. to prevent stagnating water in the pipelines, our fittings with CVD-Touch technology trigger a flow of water for 20 seconds at the latest 24 hours after the last use. (Factory setting. Specific intervals and flow times on request).

#### **Shower comfort**

All LINUS fittings are easy to operate. Zero-force actuation of the LINUS electronic models makes it both convenient and efficient. The option of being able to set extremely long flow times also makes all electronic valves the first choice for top-notch spas. Good handling of all self-closing fittings is ensured by the short actuation path for self-closing cartridges and that the mixing knob is exceptionally easy to turn.

#### **Attractive design**

For many years, SCHELL has proven that even fitting technology in public sanitary rooms can meet high aesthetic standards. Thus,

also for the topic shower fittings. The design language is clear and the materials are of high quality. The front covers of our concealed fittings have low installation heights and have slightly-rounded external contours. The sensor zone is generously proportioned, and is protected by safety glass. Just like the motto: »Shower more pleasantly«.

#### **Easy to service and mount**

No unimportant criteria when selecting the suitable shower fitting: How easy is the fitting to mount and service? A question that SCHELL answers correctly. With compact shower fittings made from few components that are partly already preassembled at the factory. With shower panels that are quick and easy to maintain. And with our technical field team who are always at your disposal for advice and deeds. The best prerequisites for quick mounting, easy care and maintenance.

Key aspects:

- Hygiene of drinking water
- Hygiene of the user
- Water-saving
- Reliable function

### Standards and directives for planning sanitary rooms (status: 4/2008)

Shower fittings by SCHELL should be mounted under consideration of the following listed standards and directives.

- DIN standards
- DVGW worksheets
- EN European standards
- ISO standards
- TrinkW (German drinking water ordinance)
- VDI directives/VDE directives
- VOB/ATV

*For precise information, refer to:*

ArbStättV	The Ordinance Governing the Workplace
BGG	Equal Treatment for Disabled Persons
DIN 1988 Part 100-600	Technical Regulations for Potable Water Installations (associated complimentary national standards to the DIN EN 806 Part 1–5)
DIN 4109	Noise protection in building construction
DIN 50930/6	Metallic materials in drinking water installations
DIN EN 200	Sanitary rooms – Draw-off taps and mixer taps for water supply systems, Type 1 and Type 2 – General Technical Specification
DVGW W 270	Protection of Drinking Water from Micro-organisms of Non-Metallic Materials
DVGW W 543	Pressure-resistant flexible hoses for drinking-water installations; Requirements and checks
DVGW W 551	Drinking-water heating and drinking-water line installations; Technical actions for reducing the spread of legionella; planning, construction, operation and decontamination of drinking-water installations
DVGW W 553	Dimensioning of circulation systems in the central drinking water heating system
EN 806 Part 1 General Part 2 Planning Part 3 refer to text Part 4 Installation Part 5 Operation and maintenance	Technical rules for drinking water installations – Part 3: Calculation of internal pipe diameters – simplified procedure; German version EN 806-3:2006
EN 1111	Thermostatic mixer (PN 10)
EN 1717	Protection of drinking water against impurities in drinking-water installations and general requirements on safety facilities for the prevention of impurities in drinking water through backflow
IfSG	Law for the prevention and control of infectious diseases amongst humans (protection against infectious diseases law)



TrinkwV 2001	German Drinking Water Regulations
VDI 3818	Public sanitary rooms, planning, construction, operation and installation
VDI 6000	Equipping of and with sanitary rooms, Sheet 1–6
VDI 6023	Sheet 1 Hygiene in drinking-water installations – requirements on planning, construction, operation and maintenance 2006-07
VDE 0100	Construction of low voltage systems
VOB 18381	German Construction and Contract Procedures – Part C: General technical contractual conditions for construction work (ATV) – gas, water and draining systems within buildings

**Shower fittings with temperature regulation**

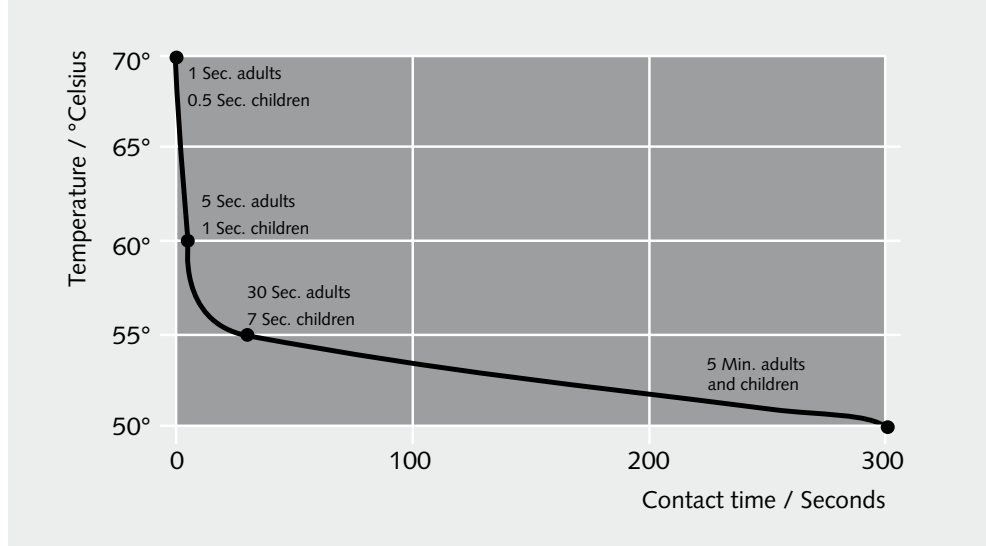

SCHELL shower fittings with thermostat are ideal for facilities where individual temperature control with precise shower temperatures are required. This design should primarily be selected if there is a danger of scalding and where high hot water temperatures are in use. The water paths for SCHELL shower fittings with thermostat have a hot water stop which also stops the hot water supply if the cold water supply fails.

Furthermore, the fitting has a release button which only permits temperatures above 38 °C when it is unlocked.

**For user groups where a risk remains of incorrect handling, a locking disc is included with the fitting, which prevents bypassing the safety stop.**

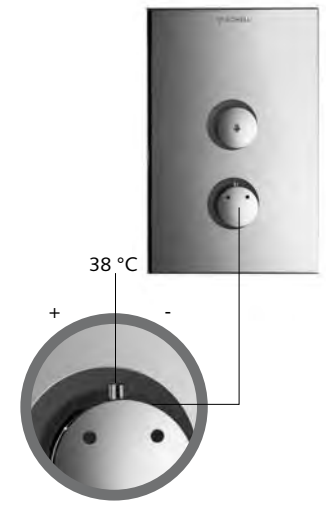

In the shower area, protection against legionella is especially important

### Risk of legionella forming

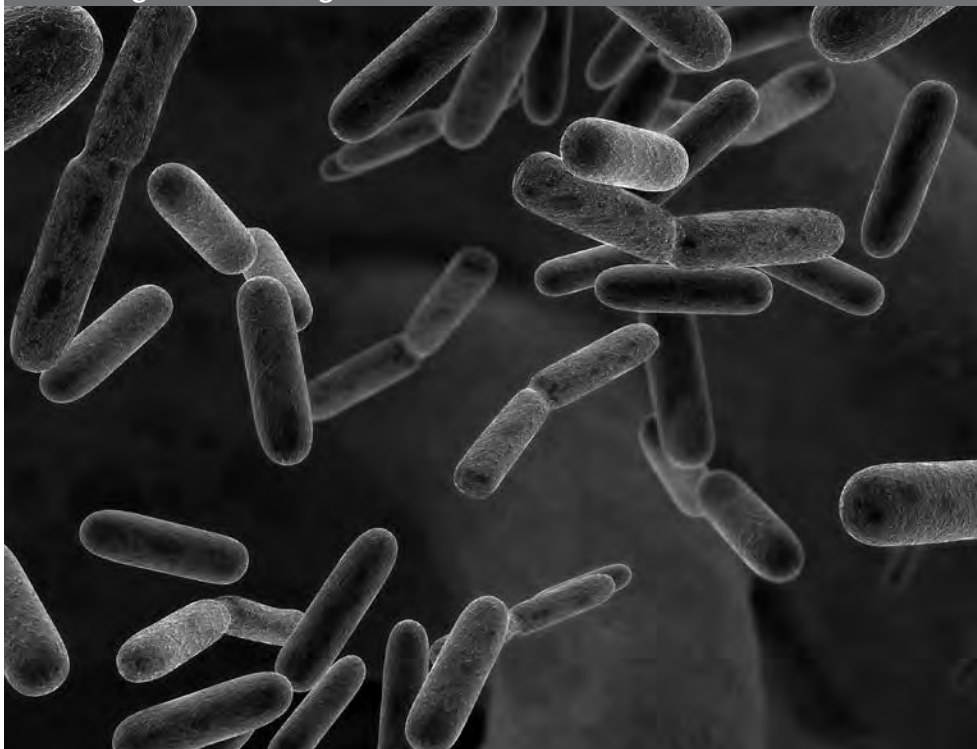

The drinking water ordinance from 2001 and associated investigations of drinking water supply systems by public health agencies show a high number of installations contaminated by legionella.

The infections are usually caught by inhaling aerosols. One of the possible clinical disease characteristics, namely »Legionella Pneumonia« can lead to major inflammatory lung conditions, which can even lead to death in certain cases where the affected person has a compromised immune system. The bacteria multiply when they find the confluence of three factors: stability, heat and food. They find the ideal condition in stagnant drinking water systems where temperatures lie between 25 °C and 45 °C. The aerosol generated during showering provides the transfer path for bacteria. People with compromised immune systems, such as residents of care homes and hospital patients, are especially at risk. However, infections can also spread in hotels or sports facilities which can endanger other groups.

### DVGW Worksheet W 551

The DVGW (German Technical and Scientific Association for Gas and Water) Worksheet W 551 makes recommendations for planning and operating drinking water systems to ensure hygienically perfect drinking water qualities at all tap points. However, it also describes various disinfection processes that can be used to disinfect systems that are already infected. Practice has shown that thermal disinfection in particular is very practicable, presupposing that it is possible to conduct hot water at 70 °C to all tap points.

**Operation:****1. Large installations**

»For large installations, the water must always be maintained to a temperature of minimum 60 °C at the water outlet... Circulation systems and self-regulating trace heating systems must be operated so that the temperature of the water in the system is not exceeded by more than 5 K compared to the temperature of the hot water at the outlet of the drinking water heater.«

**2. Operation of circulation pumps**

»Circulation pumps may only be switched off daily up to a maximum of 8 hours if systems are fully serviceable and if they have been planned and constructed in accordance with the DVGW Worksheet W 551, Chapter 5.«

**3. Small installations**

»For small installations, it is recommended to set the regulating temperature of the drinking water heater to 60 °C. Always prevent operating temperatures of 55 °C. However, if the client or operating company is informed about potential health risks (spread of legionella) within the framework of commissioning and instruction, particularly then it must be anticipated that users belong to the groups at risk. Fundamental prerequisites are that the pipelines are dimensioned in accordance with DIN EN 806 Part 3 and the complimentary national standard 1988 Part 300, as well as observing the VDI Directive 6023 »Drinking-water installations«. Further information on this topic: Publication by the UB (German federal environment office) »Drink something - drinking water out of the tap«.

**Protection through thermal disinfection**

Using thermal disinfection, the risk of legionella can be reduced to a minimum. Thereby, the complete system, must be included, also all taps. Legionella is quickly killed off at a temperature of 70 °C. Each tap point must be opened and water of at least 70 °C allowed to run for at least 3 minutes. Thus, water in the drinking water heater must be heated to more than 70 °C. The outlet temperature at each tap point must be checked. At the same time, the limited thermal output of the drinking water heater must be taken into consideration.

During thermal disinfection, make sure that no unauthorized persons access the tap points (risk of scalding). After thermal disinfection, return the system to its intended use. According to Worksheet W 551 decontamination (disinfection) is only necessary if more than 100 CFU\* in 100 ml is identified at the tap points.

Thermal disinfection must only be carried out by trained personnel, in accordance with VDI 6023 and the SCHELL instructions, under consideration of the DVGW Worksheet W 551.



**Normal mode**  
Cold/hot water with thermostat mixer

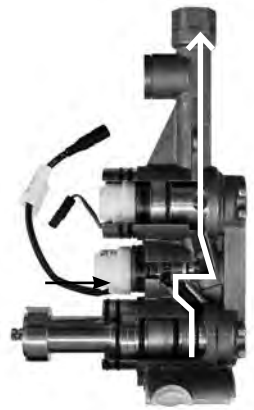

**Thermal disinfection**  
Hot water 70 °C ≥ 3 min



Key switch  
Item No. 01 538 00 99

**Simple retrofitting possible**

For the new models with thermostat, SCHELL offer the option to upgrade the fittings so that thermal disinfection can be carried out. The LINUS fittings with thermostat (D-E-T and D-SC-T) can be retrofitted with a solenoid valve to carry out thermal disinfection. For this, a solenoid valve is mounted in the fitting casing (refer to diagram).

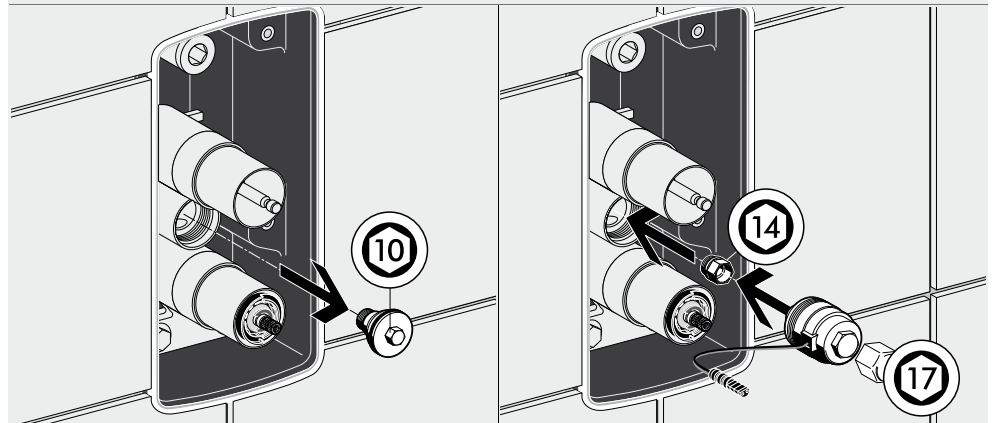

A bypass section is integrated into the body of the fitting which conducts the hot water past the thermostat valve and valve unit to the shower head. In its delivered state, the path is closed off by a plug. As required, a solenoid valve (accessories) can be retrofitted so that by actuation, the hot water can get to the shower head despite a setting lower shower temperature and, thus, conforming to the requirement of W551.

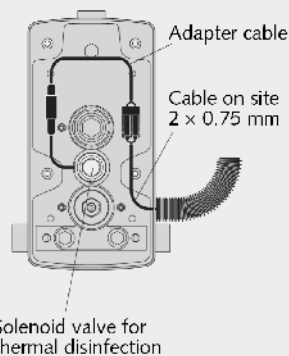

During thermal disinfection, make sure there are no user is in the shower area (risk of scalding). The operator must be instructed in accordance with the VDI worksheet 6023.

Actuation of the solenoid valve can be either via the connection in a building and control system or manually via a local key switch (accessories).

The location for installation must be planned so that the shower fittings can be checked.

**Electronic connection for thermal disinfection**

Connection at the place of installation is with a cable, min. 2 x 0.75 mm<sup>2</sup>. The solenoid valve for thermal disinfection has an adapter cable and Wago terminals for connection to an on-site cable.

The mains adapter can be positioned arbitrarily.

**Mains adapters for thermal disinfection**



Mains adapter for 1-2 solenoid valves  
Item No. 01 566 00 99



Mains adapter for 1-12 solenoid valves  
Item No. 01 490 00 99



Electrical distributor box with mains adapter for 1-12 solenoid valves  
Item No. 01 537 00 99

**Controlling the monostable solenoid valves**

The monostable solenoid valves are suitable for being controlled by key switch or for integration in the central building and control system (BACS). In both cases, the control voltage must be 12 V.

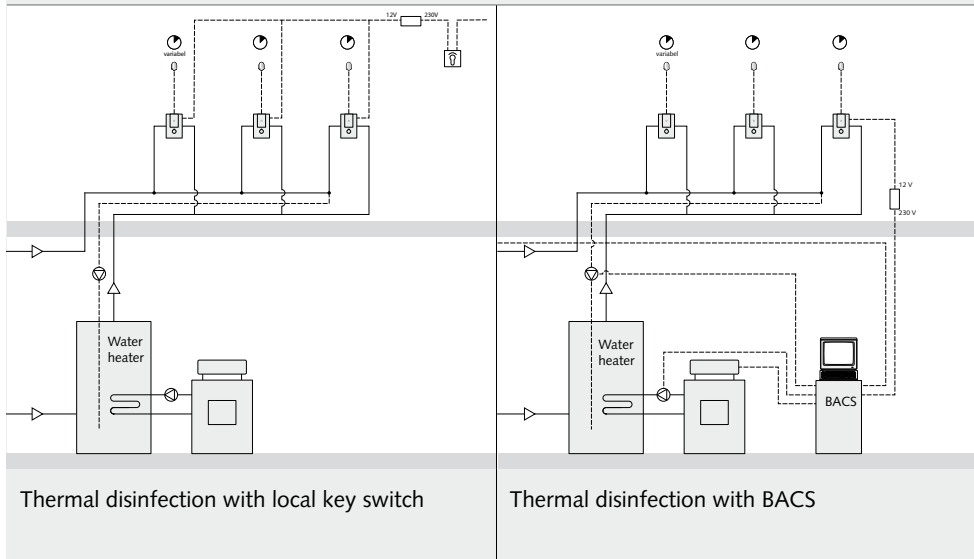

Thermal disinfection with local key switch

Thermal disinfection with BACS

**Observe: the correct size of the hot-water tank**

Depending on the capacity of the hot-water tank, it may be necessary to form multiple switching groups. Example: 6 showers each with 12 l/min flow rate, flush duration 5 min = Minimum storage capacity 360 l > 70 °C

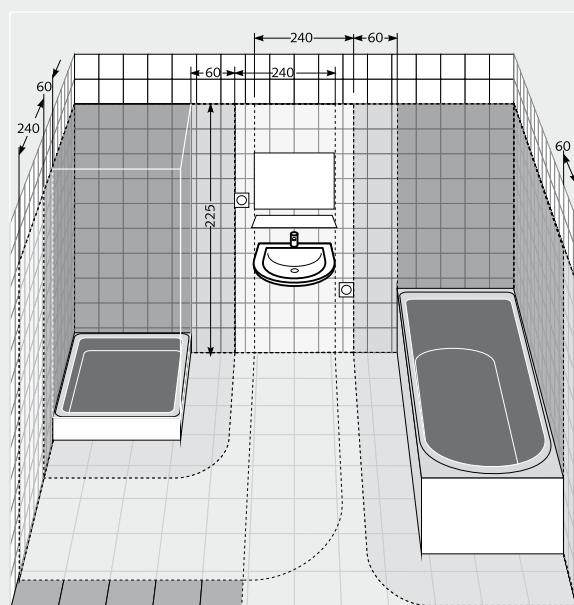

**Safety area VDE 0100**

- Area/zone 0
- Area/zone 1
- Area/zone 2
- Area/zone 3



Monostable solenoid valve 12 V – deenergized closed  
Item No. 01 875 00 99



## Electronic actuation via sensor electronics and cartridge solenoid valve

---



LINUS D-E-V/D-E-V ECO  
Page 30



LINUS D-E-T/D-E-T ECO  
Page 32

## Electronic actuation via CVD-Touch electronic and cartridge solenoid valve

---



LINUS D-C-M  
Page 38



LINUS D-C-T  
Page 40



LINUS BASIC D-C-T  
Page 40

## Manual actuation via self-closing cartridge

---



LINUS BASIC D-SC-M  
Page 46



LINUS D-SC-M/D-SC-V  
Page 48



LINUS BASIC D-SC-T  
Page 50



LINUS D-SC-T  
Page 52

## Manual control by single-lever











---



LINUS D-EH-M  
Page 56

## Concealed shower fittings. System solutions.

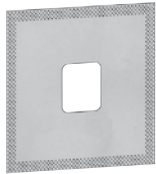
The technical basis of the SCHELL shower fittings comprising of two components: the Masterbox (WBD) in which the fitting is pre-assembled at the factory and the finishing set, comprising of a front panel with corresponding control elements. Depending on the application and function required, various designs of Masterbox and finishing sets are available. Useful accessories, e.g. the suitable mounting module and shower head turn individual components into a clever, reliable and easy to mount system.

<b>FINISHING SET</b>						
	LINUS D-EH-M	LINUS BASIC D-SC-M	LINUS D-SC-M	LINUS D-SC-V	LINUS D-C-M	LINUS D-E-V/ECO
<b>MASTERBOX</b>						
<b>ACCESSORIES</b>						
	Shower mounting module LINUS					
<b>ACCESSORIES</b>						
	Spray water adhesive flange	Shower head low-aerosol	Shower head BASIC			



FINISHING SET



LINUS BASIC D-SC-T



LINUS D-SC-T



LINUS BASIC D-C-T



LINUS D-C-T



LINUS D-E-T/ECO

MASTERBOX



ACCESSORIES



Shower mounting module LINUS

ACCESSORIES



Spray water adhesive flange







Shower head low-aerosol



Shower head BASIC

# LINUS concealed shower fittings.

## Features and fields of application.





					
	<b>LINUS D-E-T ECO/ D-E-T</b>	<b>LINUS D-C-T</b>	<b>LINUS BASIC D-C-T</b>	<b>LINUS BASIC D-SC-T</b>	<b>LINUS D-E-V ECO/ D-E-V</b>
<b>Function</b>	Electronic thermostat	CVD-Touch electronic ON/OFF/time limit - mixed water	CVD-Touch electronic ON/OFF/time limit - mixed water	Self-closing thermostat	Electronic fitting for pre-mixed water
<b>Flow time</b>	Convenient, stable flow time of 25/10 to 300 s	Flow time setting of 10 to 360 s in 10 program levels	Flow time setting of 10 to 360 s in 10 program levels	Infinitely variable flow time setting from 5 to 45 s	Convenient, stable flow time of 25/10 to 300 s
<b>Switching on</b>	Turn on effortlessly by the touch of a finger	Fingertip	Fingertip	Operate the push-button	Turn on effortlessly by the touch of a finger
<b>Switching off</b>	Turn off effortlessly by the touch of a finger Water automatically stops when flow time set has expired or when leaving the shower area (ECO).	By pressing the off button. Automatic water stop when flow time set has expired.	By pressing the off button. Automatic water stop when flow time set has expired.	Self-closing	By pressing the off button. Water automatically stopped when set flow time is exceeded and on leaving the shower area (ECO).
<b>Temperature control</b>	Precise temperature control by thermostat with hot water stop at 38 °C  Locking disc for maximum temperature limiting (protection against scalding)	Precise temperature control by thermostat with hot water stop at 38 °C  Locking disc for maximum temperature limiting (protection against scalding)	Precise temperature control by thermostat with hot water stop at 38 °C  Locking disc for maximum temperature limiting (protection against scalding)	Precise temperature control by thermostat with hot water stop at 38 °C  Locking disc for maximum temperature limiting (protection against scalding)	Systems with central thermostat
<b>Hygiene of drinking water</b>	Option to retrofit for thermal disinfection	Hygiene flush 24 h after last use, selectable  Option to retrofit for thermal disinfection  With stagnation flush program	Hygiene flush 24 h after last use, selectable  Option to retrofit for thermal disinfection  With stagnation flush program	Retrofitting option for prevention of legionella	
<b>Power supply</b>	Mains or battery (ECO only in mains mode)	Mains mode 9V or battery	Mains mode 9V or battery	Required for legionella switching and mains connection	Mains or battery (ECO only in mains mode)
<b>Design</b>	Electronic with bistable solenoid valve	Electronic with bistable solenoid valve	Electronic with bistable solenoid valve	Self-closing cartridge made from corrosion resistant plastic	Electronic with bistable solenoid valve
<b>Particularly suitable for:</b>	Fitting for systems with high demands on convenience, design and hygiene (legionella switching)	Deluxe fittings for sanitary installations with a high standard of hygiene (legionella switching), protection against scalding and option of individual temperature setting	Vandal-proof deluxe fitting for harsh use and high standard of hygiene (thermal disinfection), protection against scalding and option of individual temperature setting	Deluxe fittings for sanitary installations with a high standard of hygiene (legionella switching), protection against scalding and option of individual temperature setting	A fitting with design standards and the need for convenience and for a consistent outlet temperature (controlled by central thermostat)

**Legend**

D = Shower  
E = Electronics  
M = Mixed water  
SC = Self-closing  
T = Thermostat

WB = Pre-mixed water  
WB = Concealed Masterbox  
W = Wall-mounted tap  
ECO = Room monitoring (user-controlled water stop)

C = CVD-Touch electronic (vandal-proof multi-function buttons for On/Off time control with individual adjustable stagnation flush)

				
LINUS D-C-M	LINUS D-SC-M	LINUS D-SC-V	LINUS BASIC D-SC-M	LINUS D-EH-M
CVD-Touch electronic ON/OFF/time limit - mixed water	Self-closing mixed water	Self-closing pre-mixed water	Self-closing mixed water	Single-lever mixed water
Flow time setting of 10 to 360 s in 10 program levels	Infinitely variable flow time setting from 5 to 45 s	Infinitely variable flow time setting from 5 to 45 s	Infinitely variable flow time setting from 5 to 45 s	
Fingertip	Operate the pushbutton	Operate the pushbutton	Operate the pushbutton	
By pressing the off button. Automatic water stop when flow time set has expired.	Self-closing	Self-closing	Self-closing	
Mixed control using an actuation handle with the option of limiting the hot water volume	Mixed control using an actuation handle with the option of limiting the hot water volume		Mixed control using an actuation handle with the option of limiting the hot water volume	
With stagnation flush program				
Mains mode 9V or battery				
Electronic with bistable solenoid valve	Self-closing cartridge made from corrosion resistant plastic	Self-closing cartridge made from corrosion resistant plastic	Self-closing cartridge made from corrosion resistant plastic	Single lever handle with spout
Cost-effective solution with CVD-Touch electronic	Cost-effective solution for public facilities	Cost-effective solution for public facilities	Cost-effective solution for public facilities	Cost-effective solution for public facilities

All fittings suitable to use with drinking water, in accordance with the 2011 revised drinking water ordinance Special applications on request.  
 SCHELL offers sampling adapters for the shower heads low-aerosol and BASIC for sampling, in accordance with Drinking Water Ordinance (TrinkwV) 2011 Appendix 4 Part II.

Sampling adapter SCHELL shower head low-aerosol Item No. 01 817 00 99  
 Sampling adapter SCHELL shower head BASIC Item No. 01 816 00 99

### Planning tips

In order to make your planning easier for SCHELL concealed shower fittings, we have summarized some important planning tips. For detailed information, available as a download, refer to our mounting instructions under [www.schell.eu](http://www.schell.eu).

### Installation dimensions

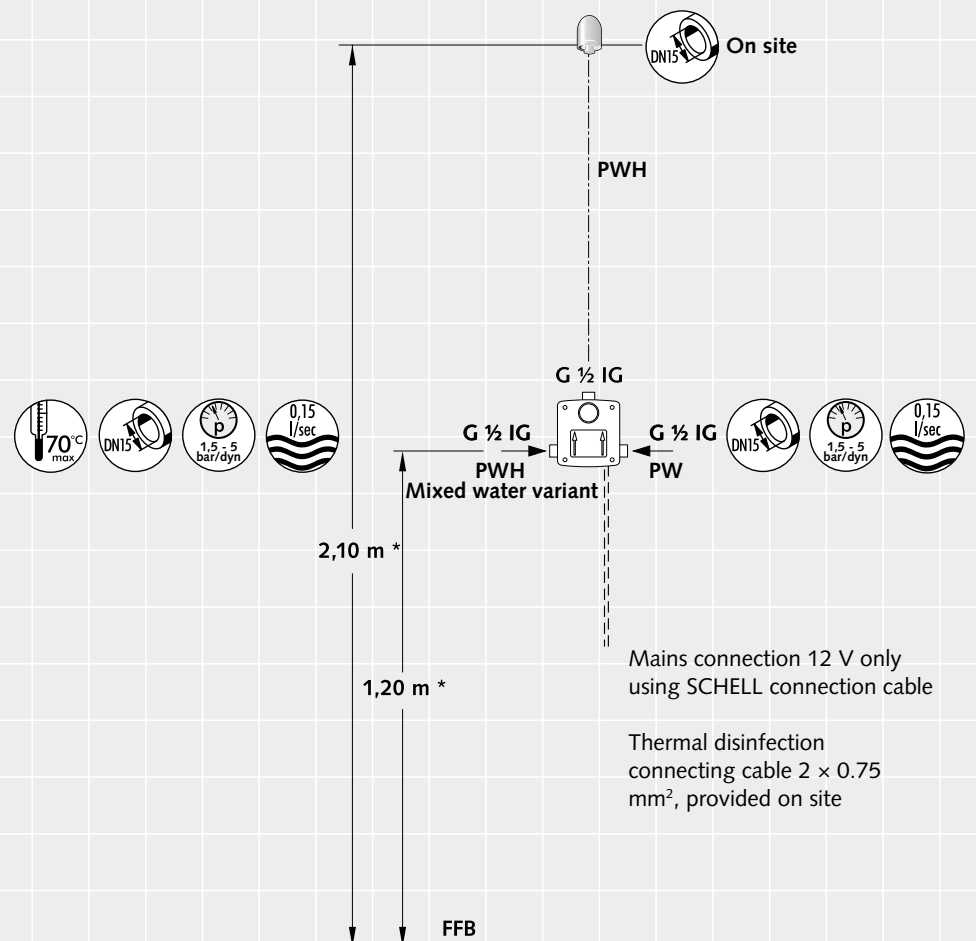

**Legend:**

- PW = Drinking water
- PWH = Drinking water, warm
- PWC = Drinking water, cold
- PWH-C = Drinking water, warm (circulation)

\* Recommended installation dimensions  
 Pressure differential cold/hot water < 1.0 bar.

**Tips:**

1. As necessary, adapt the recommended installation dimensions (e.g. facilities suitable for disabled persons).
2. In facilities frequently used by small children, make sure that the actuation is within their reach. Preferably in the D-S-C/D-E-T/D-C-T design with temperature limiting.
3. In order to permanently have hot water in the fitting, a circulation line should be provided.
4. Route electric cable in protective pipe (on site)

### SCHELL shower mounting module LINUS



SCHELL has developed a mounting module that is suitable for concealed fittings. The shower mounting module LINUS has predrilled support holes for all SCHELL Masterboxes.

Quick and precise preassembly enables optimum noise protection. Powder coating provides corrosion protection.

In-line mounting is also possible here, using the SCHELL rail installation system.

Shower mounting module LINUS  
Item No. 03 257 00 99

### Characteristics

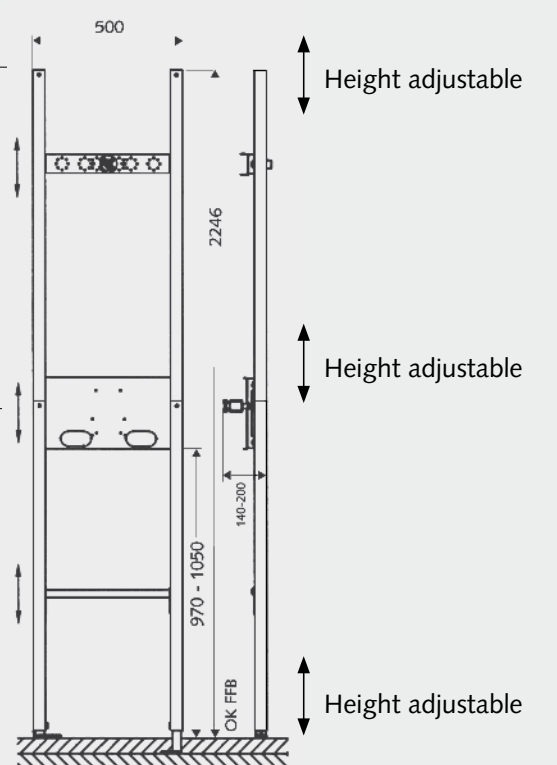

Accessories: Wall bracket (depth adjustable) Item No. 03 258 00 99

Fittings support

500

2246

970 - 1050

140-200

OK FFB

Height adjustable

Height adjustable

Height adjustable

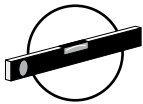

The roughing-in kit must be positioned horizontal!

The specified minimum installation depths apply to the front edge of the tiles.

Instruct the tiler about the narrow gaps (< 4 mm).

**Installation instructions**

**Installation depth Masterbox**

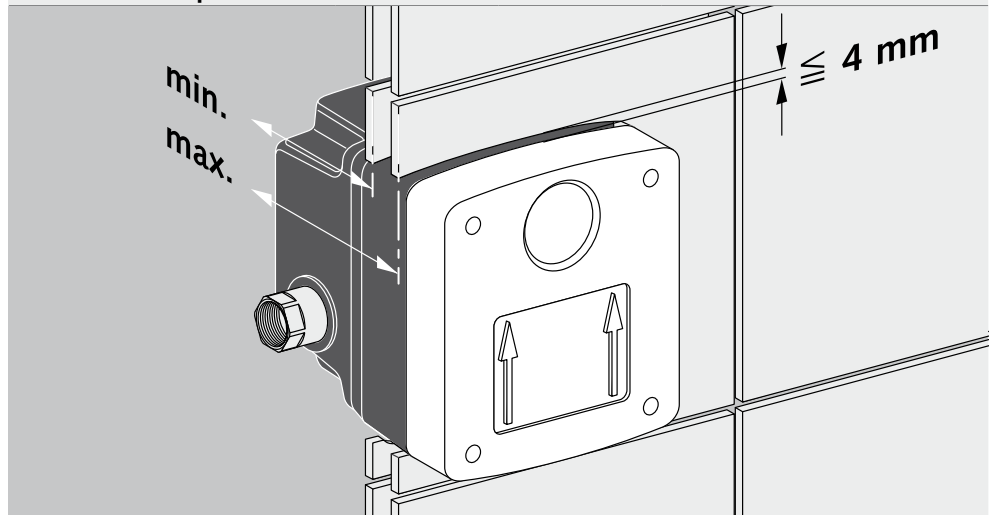

The installation depth of the roughing-in set can vary (front edge of roughing-in set)

Type	min.	max.
WBD-E-V	85 mm	144 mm
WBD-E-M	80 mm	104 mm
WBD-SC-M	80 mm	104 mm
WBD-SC-V	80 mm	104 mm
WBD-EH-M	80 mm	104 mm
WBD-SC-T	88 mm	112 mm
WBD-E-T	88 mm	112 mm

If the installation position is too low, extension kits of 25 mm and 50 mm are available for the finishing sets.

**Mounting spray-water flange**

**Note**

In accordance with DIN 18 195 Section 9, spray-water protection must be mounted for every dry construction to protect the planking and the gap between casing and tiles must also be permanently flexible.

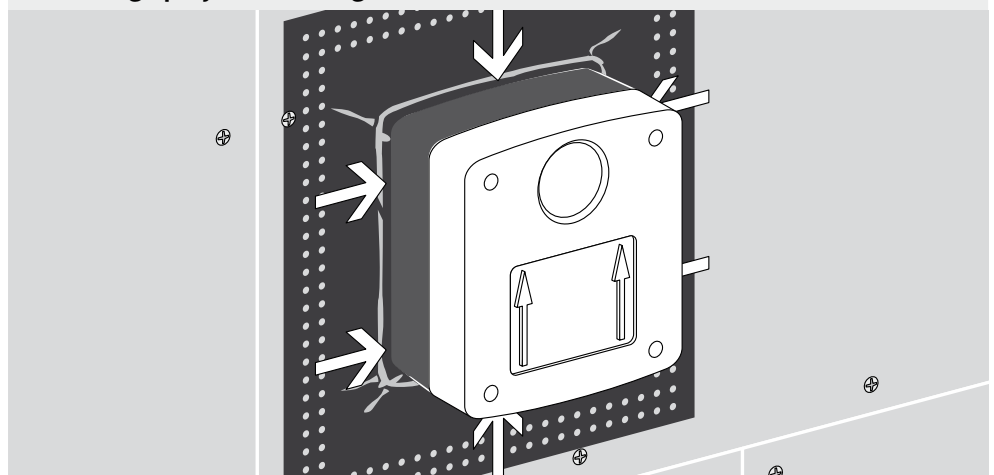

**Spray-water flange for**

WBD-SC-M/WBD-SC-V/ WBD-E-M/WBD-E-V	Item No. 01 857 00 99
WBD-SC-T/WBD-E-T	Item No. 01 856 00 99

**Mounting finishing set LINUS**

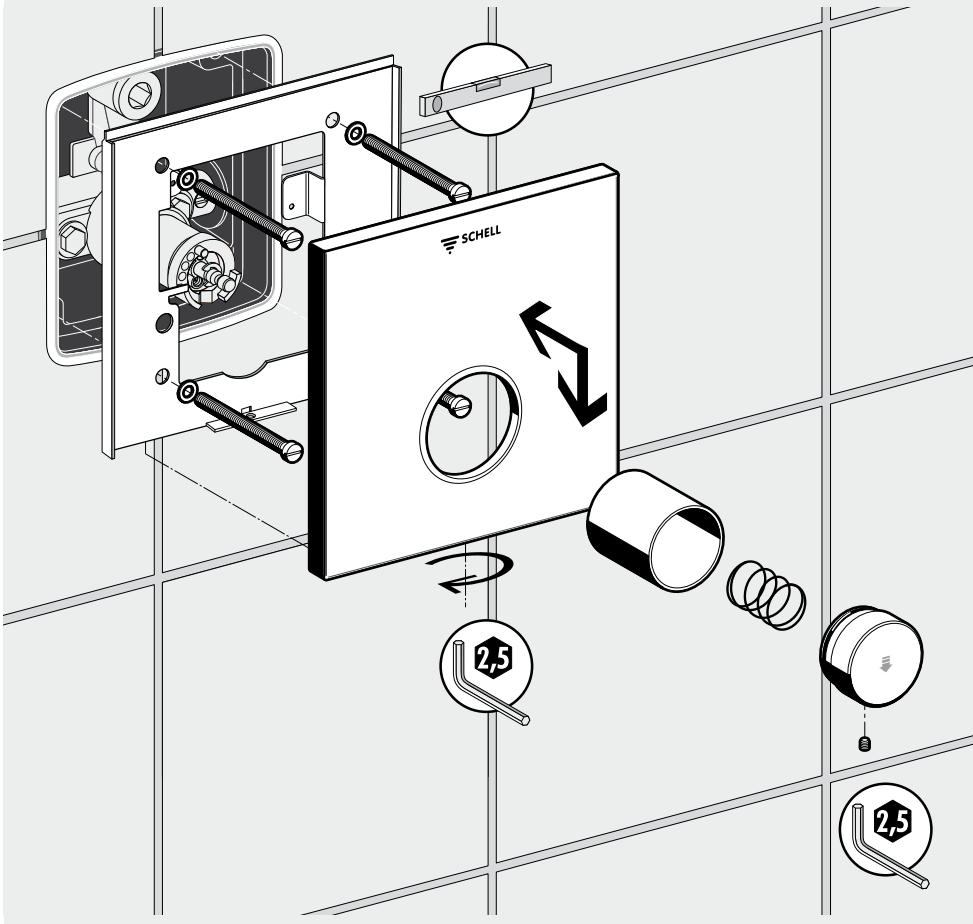

- Easy and safe mounting
- Mount frame
  - Attach front panel
  - Front panel is secured with screws against wilful removal

**Mounting finishing set LINUS BASIC**

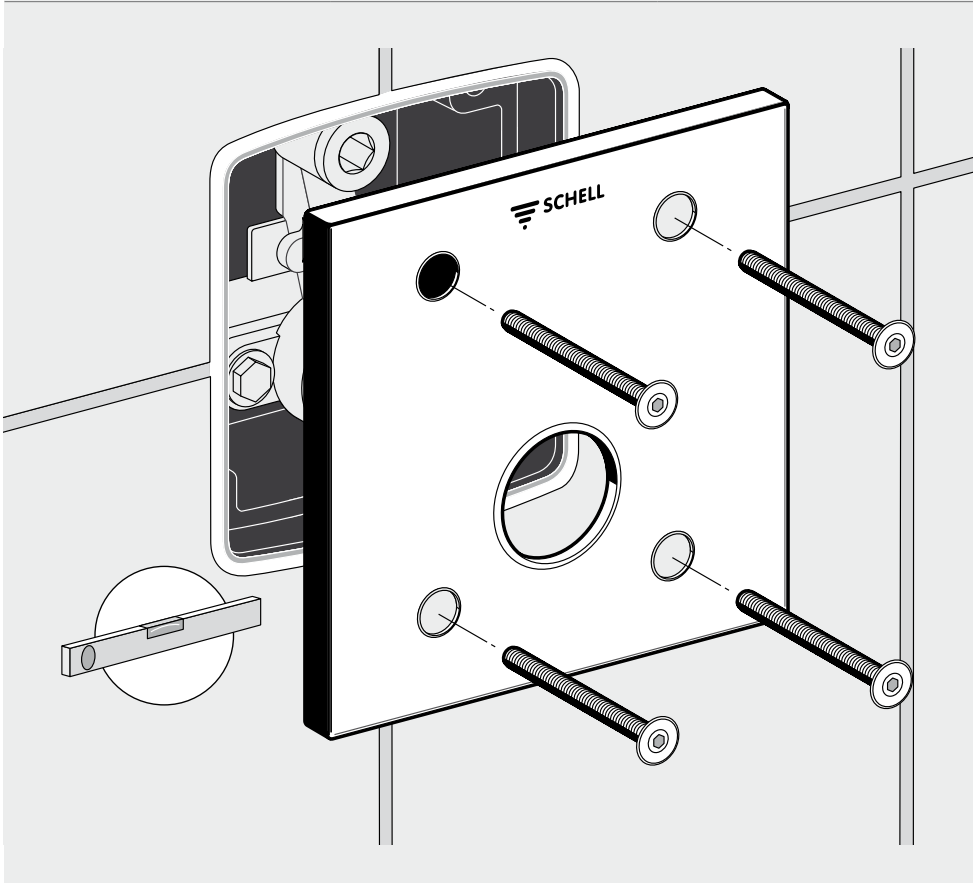

- Easy and safe mounting
- Attach front panel
  - Use the Allen key to secure the front panel



- Installed flush and vandal-proof in the front panel: the sensor field made from 6 mm thick safety glass.



## Electronic sensor fittings. By SCHELL.

Programmed to save water and for comfort.

With their electronic shower fittings, SCHELL provide an innovative answer to the high requirements in public, semi-public and commercial sanitary rooms. By simply touching the On and Off switch symbol on the sensor field, the intelligent electronics behind the safety glass immediately respond. The water flow time can be preset a is a maximum of 300 seconds. The ECO designs have proven to be particularly water-saving and comfortable. The radar sensors behind the safety glass

register the presence of the user and automatically stops the flow of water as soon as the sensor range is vacated. However, the electronic shower fittings not only offer innovative functions, but also convince through appealing design and easy mounting. Typical SCHELL.

Electronic shower fittings are particularly suitable for:

- Hotel spas and leisure pools
- Wellness and saunas facilities
- Senior citizens and care homes
- Schools
- Nurseries
- Industrial facilities
- and much more

Electronic fittings for pre-mixed water:



LINUS D-E-V/LINUS D-E-V ECO

Electronic fittings with thermostat control:



LINUS D-E-T/LINUS D-E-T ECO

## LINUS shower fittings with sensor electronic

### Functional description

The shower procedure of fittings with sensor electronics is started by a light contact with the capacitive sensor switch. The user can accurately preselect the maximum flow times using the flow time potentiometer. The flow times are between 10 and 300 s. If the system pressure should fluctuate, it will have no influence on the preset flow time. The water flow can be stopped at any time using the sensor switch.

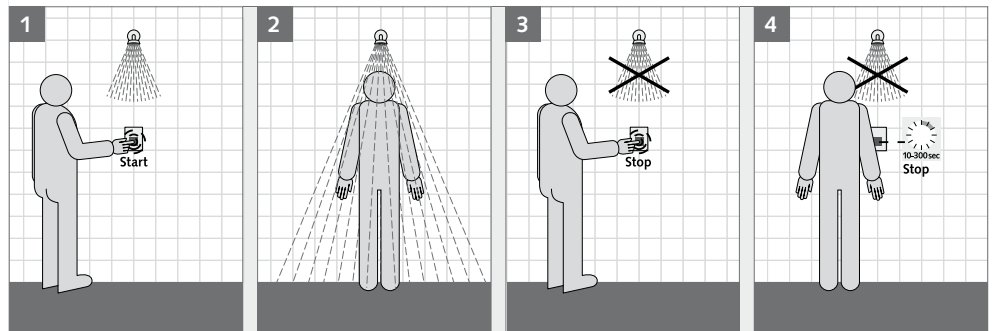

### Flow time program

- |                    |  |
|--------------------|--|
| <b>1 Start</b>     | Touch the sensor switch - water flows – water flows  |
| <b>2 Showering</b> | Water flows for the flow time set (10–300 s) (factory setting 25 s)                            |
| <b>3 Stop</b>      | Stop flow of water before end of the flow time set: Touch the sensor switch, run-on time 1–2 s |
| <b>4 Restart</b>   | refer to Figure 1  |

### Operating instructions for the standard electronics

During commissioning of the installation, the off function button of the off impulse can be switched on or off if only the flow time set should be controlled (switching off unintentionally). The SCHELL standard electronics is suitable for both mains and battery mode.

- 1 Max. flow time 10–300 s (Recommended: approx. 25 s for the public area)
- 2 Diode flashes when battery status is low
- 3 Function:



**ON:** Off button activated (as delivered)



**OFF:** No option for a switch off button

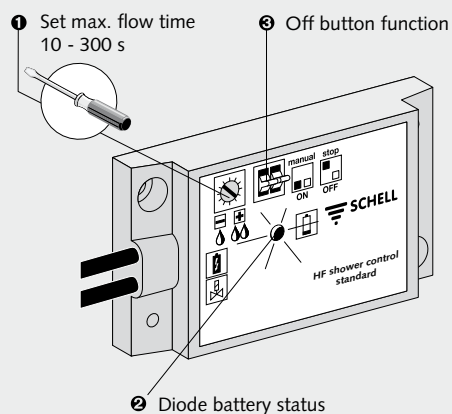

Electronic module

## LINUS shower fittings with SCHELL ECO sensor electronic

### Functional description

The SCHELL ECO electronics distinguishes itself by zero-force actuation of the water flow and an efficiently convenient flow time. The shower procedure is started by lightly touching the capacitive sensor switch. At the flow time potentiometer, the operator of the installation can preselect flow times between 25 and 300 s, which can be precisely repeated. If the user should leave the sensor field before expiry of the flow time set, the water flow will automatically stop after a short run-on time.

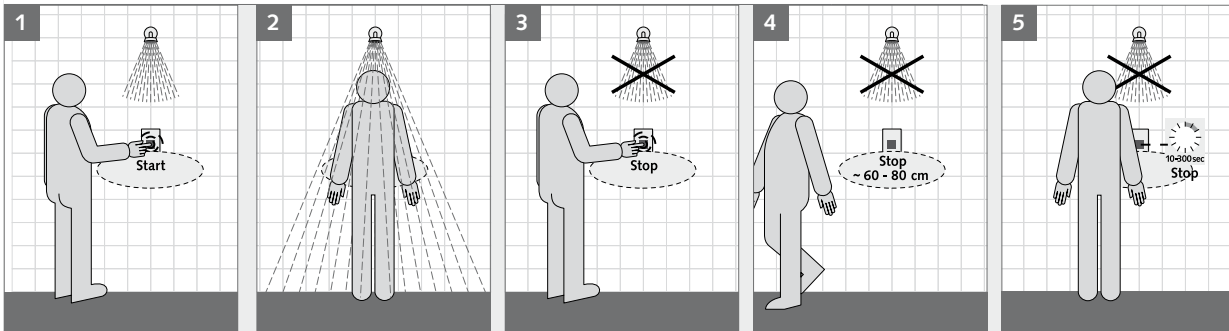

### Flow time program

- |                      |  |
|----------------------|--|
| <b>1 Start</b>       | Touch the sensor switch - water flows for 25 s even without user detection (adjust the shower temperature or waiting time until hot water reaches the tap point) |
| <b>2 Showering</b>   | Water flows until expiry of the flow time set, 25–300 s (factory setting 60 s)   |
| <b>3 Button stop</b> | Again Press the sensor switch again before expiry of the flow time set, run-on time 1–2 s  |
| <b>4 User stop</b>   | User leaves the sensor field – shower stops after run-on time 5–7 s Run-on time (ECO function)   |
| <b>5 Restart</b>     | As described below, Figure 1   |

### Operating instructions for the ECO electronic fitting

During commissioning, the switch stop function can be switched on or off by a DIP switch and the range of the sensor field can also be reduced, e.g. when using shower cabins. The SCHELL ECO electronics can only be installed for mains mode.

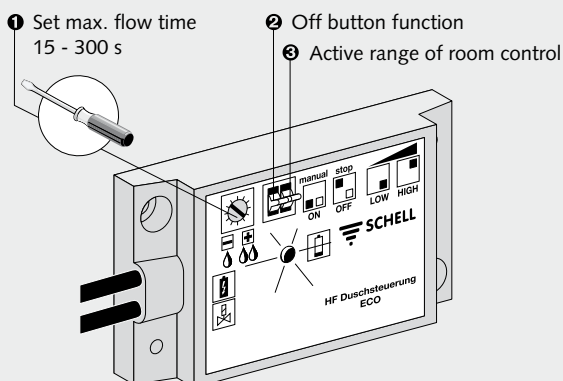

Electronic module

1 Max. flow time 25–300 s (basic flow time set 25 s)

2 Function:



ON: Off button activated (as delivered)



OFF: No option for a switch off button

3 Active range, room monitoring:



HIGH: Sensor range approx. 0.8 m



LOW: Sensor range approx. 0.5 m

Only SCHELL mains adapters and cables must be installed.



Fig. 1  
SCHELL mains adapter LINUS sensor electronics 230 V/9 V 1-2 fittings  
Item No. 01 491 00 99

**Power supply, sensor electronic fittings**

**Mains operation for electronic connection**

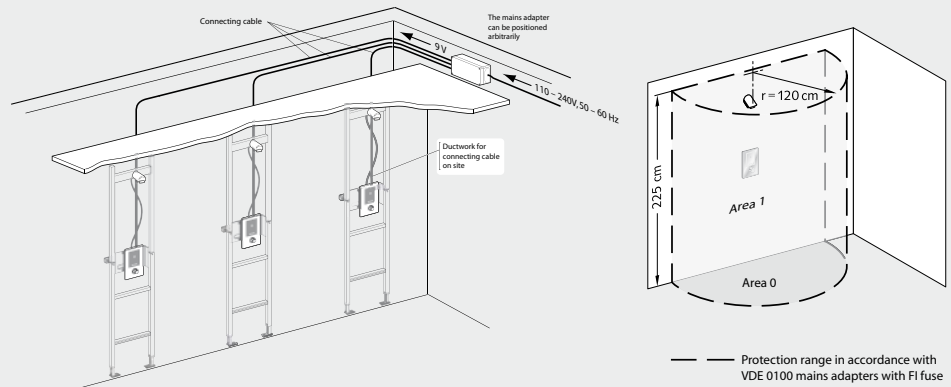

The mains connection to the fittings must only be through a low voltage, max. 9 V. The mains adapters are available for 1 - 2 or 1 - 12 fittings and must be installed outside of the VDE 0100 protection zones. The spatial position of the power connections must be planned so they are close enough (note cable length 10 m: Item No. 01 493 00 99, 5 m: Item No. 01 492 00 99) and accessible.



Fig. 2  
SCHELL top-hat rail mains adapter LINUS sensor electronics 230 V/9 V 1-12 fittings  
Item No. 01 555 00 99

**SCHELL mains adapter LINUS 1 - 2 sensor electronics (Fig. 1)**

The mains adapter is provided with screw lugs which are used for mounting.

**Technical Data**

Input 230 V 50/60 Hz

Output 9 V ± 1.5 V DC, stabilised

Output voltage 40 mA continuous current, 100 mA momentary

Protection class IP 20

**SCHELL top-hat rails mains adapter LINUS sensor electronics 1-12 fittings (Fig. 2)**

The mains adapter is prepared for mounting on a 35 mm top hat rail (EN 522) (top-hat rail and terminal strip provided on site).

**Technical Data**

Input 100-240 V, 50-60 Hz

Output 9 V, 1A

Protection class IP 20

**Accessories**



Electric junction box  
LINUS sensor electronics  
1-12 fittings  
Item No. 01 556 00 99



Connecting cable LINUS D-E-V/D-E-T  
Length of cable 5 m,  
Item No. 01 492 00 99  
Length of cable 10 m,  
Item No. 01 493 00 99



Key switch for thermal disinfection  
Item No. 01 538 00 99

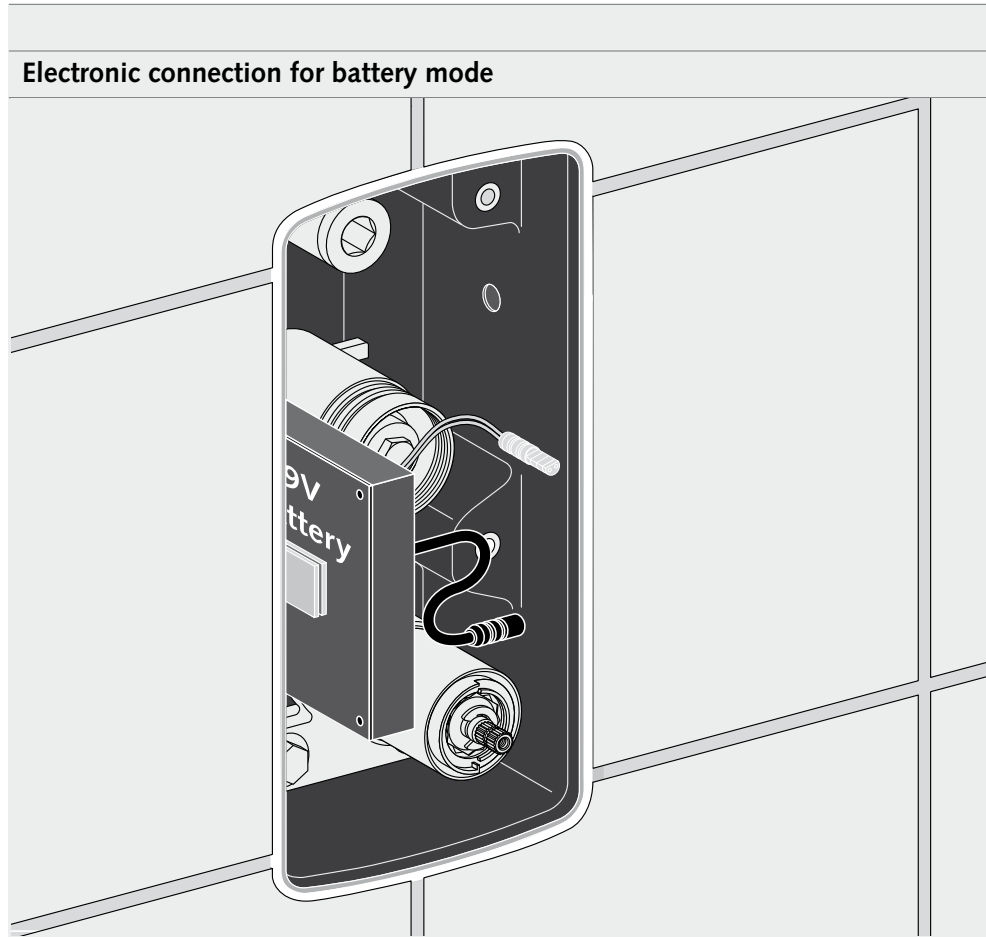
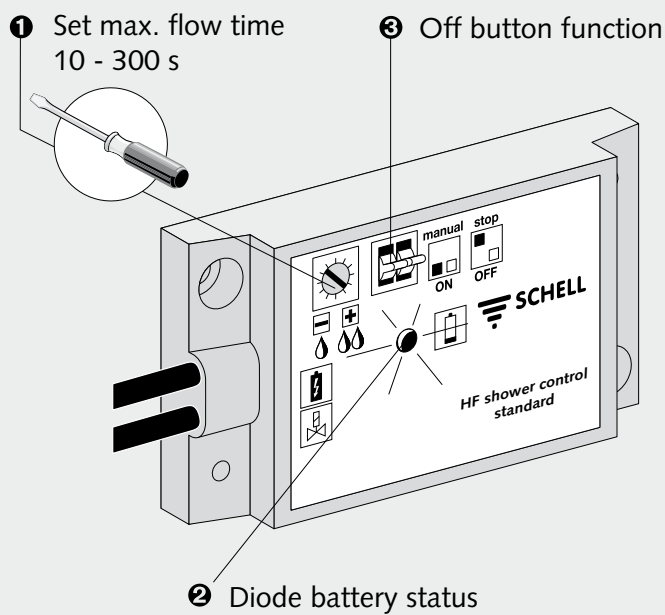

Fig. 3  
SCHELL battery compartment 9 V  
Item No. 01 853 00 99

Battery mode is only suitable for a standard electronic fitting, not for ECO. Install the battery compartment (Fig. 3) into the Masterbox from the side (refer to diagram). All cables are correctly preassembled with plugs. If it is necessary to replace a battery (6x1.5 AA), it is indicated by the flashing diode (refer to the electric module).





Type: Linus D-E-V ECO / D-E-V



Masterbox WBD-E-V

## Concealed shower LINUS D-E-V ECO/D-E-V + Masterbox

### Features

Electronic shower fitting finishing set incl. concealed-Masterbox WBD-E-V with sealed casing fairleads, electric switch.

### Technical Data

Roughing-in set, Type	D-E-V ECO	D-E-V
Function	On/off/room monitoring	On/off
Flow time setting	25–300 s	10–300 s
Temperature range	38 °C	38 °C
Dimensions H,W,D	188 mm × 180 mm × 11,5 mm	188 mm × 180 mm × 11,5 mm
Power supply	Mains mode	Mains/battery mode
Material	Front panel made of stainless steel with safety glass	

### Actuation

Water ON	Touch the capacitive pushbutton
Water OFF	1. Touch the capacitive pushbutton
	2. Leaving the sensor area (only D-E-V ECO)
	3. Expiry of flow time set

Corresponding Masterbox	WBD-E-V
Function	Electronic - pre-mixed or cold water
Flow time setting	With electronic module finishing set
Temperature range	Pre-mixed water
Dimensions H,W,D	149 mm × 138 mm × 120 mm
Installation depth	104 mm – 144 mm
Flow pressure	1,5–5,0 bar
Flow rate	≤ 15 l/min at 3 bar flow pressure
Water connections	2 × G 1/2 IG (DIN ISO 288-1)
Noise insulation class	I
Test mark	P-IX 18008/IA, Belgaqua
Material	Water path made from dezincification-resistant brass Supply connections of red brass

**Scope of delivery finishing set LINUS D-E-V ECO/D-E-V**

- Front panel with switch panel under scratch-proof and unbreakable glass element
- Mounting frame with integrated electronic module
- Attachment material

Versions	Chrome front panel	Stainless steel front panel
D-E-V ECO	Item No. 01 831 06 99	Item No. 01 831 28 99
D-E-V	Item No. 01 830 06 99	Item No. 01 830 28 99

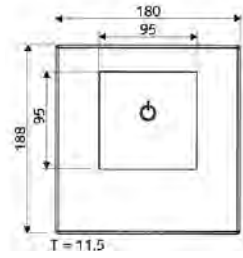

**Scope of delivery Masterbox**

- Fitting casing with: pre-filter, isolating valve, backflow preventer
- Concealed box
- Electronic Cartridge solenoid valve
- Attachment material
- Through-flow connection piece
- Protective cover

<b>Masterbox WBD-E-V</b>	<b>Item No. 01 822 00 99</b>
--------------------------	------------------------------

**Recommended accessories (for dry construction mounting)**

<b>Spray water adhesive flange</b> (Dimensions: 425 mm x 425 mm)	<b>Item No. 01 857 00 99</b>
---	------------------------------

**Accessories for all types**

<b>Shower mounting module LINUS</b>	<b>Item No. 03 257 00 99</b>
<b>Wall mounting set (wall-mounted installation)</b>	<b>Item No. 03 258 00 99</b>
<b>SHELL mains adapter 230 V, 50/60 Hz / 9 V</b>	<b>Item No. 01 491 00 99</b>
<b>SHELL mains adapter 100–240 V, 50/60 Hz / 12 V</b>	<b>Item No. 01 555 00 99</b>
<b>Electric junction box</b>	<b>Item No. 01 556 00 99</b>
<b>Connecting cable 5 m</b>	<b>Item No. 01 492 00 99</b>
<b>Connecting cable 10 m</b>	<b>Item No. 01 493 00 99</b>
<b>Battery compartment (only for D-E-V)</b>	<b>Item No. 01 853 00 99</b>
<b>Shower head BASIC</b>	<b>Item No. 01 844 06 99</b>
<b>Shower head low-aerosol</b>	<b>Item No. 01 814 00 99</b>

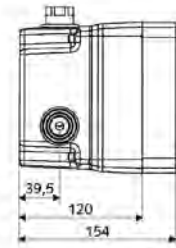
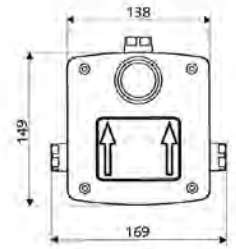

Shower mounting module LINUS

Concealed solutions



Type: LINUS D-E-T ECO / D-E-T



Masterbox WBD-E-T

### Concealed shower LINUS D-E-T ECO/D-E-T + Masterbox

#### Features

Electronic shower fitting finishing set incl. concealed-Masterbox WBD-E T with sealed casing fairleads, electric switch.

#### Technical Data

Finishing set, Type	LINUS D-E-T ECO	LINUS D-E-T
Function	On/off/room monitoring - thermostat	On/off - thermostat
Flow time setting	25–300 s	10–300 s
Temperature range	Thermostat actuation with hot water stop at 38 °C	
Dimensions H,W,D	281 mm × 173 mm × 11.5 mm	281 mm × 173 mm × 11.5 mm
Power supply	Mains mode	Mains/battery mode
Material	Front panel made of stainless steel with safety glass Operation, spout made of chrome-plated brass	

Actuation	
Water ON	Touch the capacitive pushbutton
Water OFF	1. Touch the capacitive pushbutton 2. Leaving the sensor area (only LINUS D-E-T ECO) 3. Expiry of flow time set

Corresponding Masterbox	WBD-E-T
Function	Electronic-thermostat
Flow time setting	with electronic module finishing set
Temperature range	5–45 °C (70 °C, short-time use)
Dimensions	246 mm × 112 mm × 125 mm
Installation depth	88 mm – 112 mm
Flow pressure	1,0–5,0 bar
Flow rate	≤ 15 l/min at 3 bar flow pressure
Water connections	3 × G 1/2 IG (DIN ISO 228-1)
Noise insulation class	I
Test symbol	P-IX 18001/IA, Belgaqua
Material	Water path made from dezincification-resistant brass Supply connections of red brass



Scope of delivery finishing set LINUS D-E-T ECO/D-E-T	
<ul style="list-style-type: none"> <li>• Front panel with switch panel under scratch-proof and unbreakable glass element</li> <li>• Mounting frame with integrated electronic module</li> <li>• Actuating button with spout and hot water stop at 38 °C</li> <li>• Locking disc for maximum temperature limiting (protection against scalding)</li> <li>• Attachment material</li> </ul>	

Versions	Chrome front panel	Stainless steel front panel
D-E-T ECO	Item No. 01 808 06 99	Item No. 01 808 28 99
D-E-T	Item No. 01 807 06 99	Item No. 01 807 28 99

Scope of delivery Masterbox WBD-E-T	
<ul style="list-style-type: none"> <li>• Fitting casing with: pre-filter, isolating valve, backflow preventer</li> <li>• Concealed box</li> <li>• Electronic cartridge solenoid valve</li> <li>• Thermostat cartridge in accordance with EN 1111 with changeable 38 °C temperature lock and safety lock in the event of failure of cold water, with spout</li> <li>• Attachment material/protective cover</li> <li>• Through-flow connection piece/flush nozzle</li> </ul>	

Masterbox WBD-E-T	Item No. 01 802 00 99
-------------------	-----------------------

Recommended accessories (for dry construction mounting)	
Spray water adhesive flange (Dimensions: 425 mm × 425 mm)	Item No. 01 856 00 99

Accessories for all types	
Shower mounting module LINUS	Item No. 03 257 00 99
Wall bracket kit (wall-mounted installation)	Item No. 03 258 00 99
Mains adapter 230 V, 50/60 Hz, 9 V for 1–2 fittings	Item No. 01 491 00 99
Mains adapter 100–240 V, 50/60 Hz, 12 V for 1–12 fittings	Item No. 01 555 00 99
Electric junction box with mains adapter 100 – 240 V, 50/60 Hz, 12 V for 1–12 fittings	Item No. 01 556 00 99
Connecting cable 5 m	Item No. 01 492 00 99
Connecting cable 10 m	Item No. 01 493 00 99
Battery compartment (only for D-E-V)	Item No. 01 853 00 99
Extension kit 25 mm	Item No. 01 860 06 99
Extension kit 50 mm	Item No. 01 865 06 99
Shower head BASIC	Item No. 01 844 06 99
Shower head low-aerosol	Item No. 01 814 00 99

For thermal disinfection	
Key switch	Item No. 03 258 00 99
Monostable solenoid valve 12 V	Item No. 01 875 00 99
Concealed mains adapter 100–240 V, 50/60 Hz, 12 V for 1–2 solenoid valves	Item No. 01 566 00 99
Mains adapter 100–240 V, 50/60 Hz, 12 V for 1–12 solenoid valves	Item No. 01 490 00 99
Electric junction box with mains adapter 100 – 240 V, 50/60 Hz, 12 V for 1–12 solenoid valves	Item No. 01 566 00 99

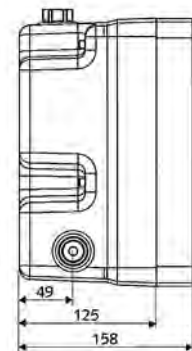
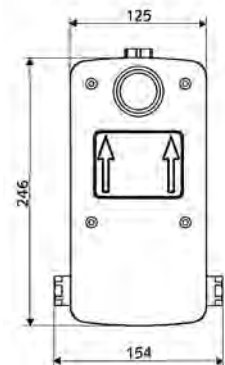
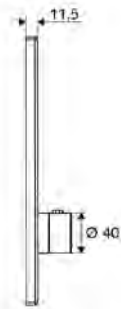
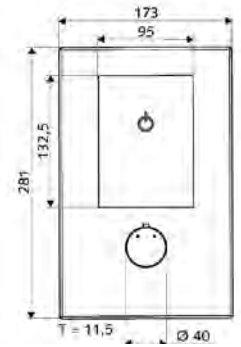

 SCHELL



• Vandal-proof multi-function buttons for On/Off time control with individual adjustable stagnation flush.



## CVD-Touch electronic-controlled concealed fittings. By SCHELL.

Enjoying a shower at the push of a button.

Also included in the diversity of the range by SCHELL is the self-closing shower fittings with intelligent CVD-Touch technology (pressure-intensive actuation element for electronic fittings).

The flow times can be individually set (10–360 s), set individually in 10 program levels (special flow times on request). In order to save water, the flow can also be prematurely stopped by tapping on the CVD-Touch electronic.

The programmable stagnation

flush automatically actuated every 24 hours after the last flush ensures increased hygiene (special flow time and stagnation intervals on request). A clever solution, created for application in public sanitary rooms.

CVD-Touch electronically-controlled shower fittings are particularly suitable for:

- Hotel spas and leisure pools
- Wellness and saunas facilities
- Senior citizens and care homes
- Schools
- Nurseries
- Industrial facilities
- and much more

---

SCHELL shower fittings with CVD-Touch electronic are available with thermostat control or for mixed water.



LINUS D-C-M



LINUS D-C-T



LINUS BASIC D-C-T

Only SCHELL mains adapters and cables must be installed.



Fig. 1  
SCHELL concealed mains adapter CVD-Touch electronic 230 V/9 V for 1 – 12 CVD-Touch electronic  
Item No. 01 315 00 99

**Power supply, sensor electronic fittings**

**Mains operation for electronic connection**

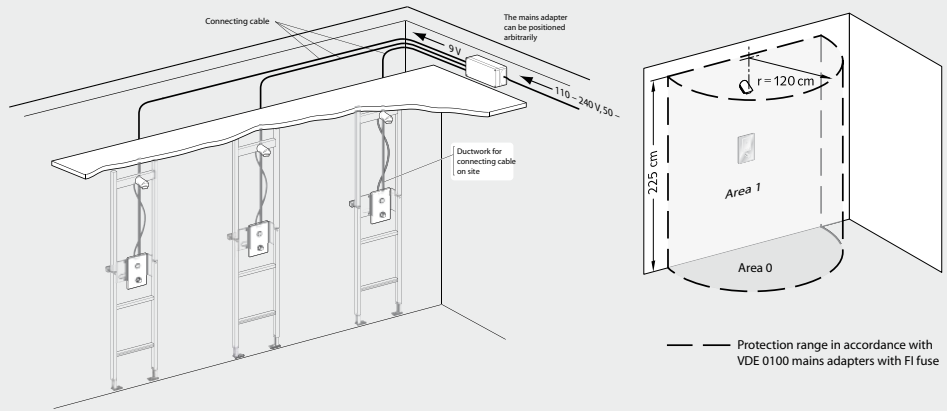

The mains connection to the fittings must only be through a low voltage, max. 9 V. The mains adapters are available for 1 - 2 or 1 - 12 fittings and must be installed outside of the VDE 0100 protection zones. The spatial position of the power connections must be planned so they are close enough (note cable length 10 m: Item No. 01 570 00 99, 5 m: Item No. 01 571 00 99) and accessible.

**SCHELL concealed mains adapter CVD-Touch electronic 1–12 fittings (Fig. 1)**

**Technical Data**

Input 100 – 240 V, 50 – 60 Hz braid cable

Output 9 V ± 0.66 A DC at plug



Fig. 2  
SCHELL top-hat rail mains adapter CVD-Touch electronic 230 V/9 V  
For 1–12 CVD-Touch electronic units  
Item No. 01 582 00 99

**SCHELL top-hat rail mains adapter CVD-Touch electronic 1–12 fittings (Fig. 2)**

The mains adapter is prepared for mounting on a 35 mm top hat rail (EN 522) (top-hat rail and terminal strip provided on site).

**Technical Data**

Input 100–240 V, 50–60 Hz braid cable

Output 9 V ± 0.66 A DC at plug

**Accessories**



SCHELL Electric junction box CVD-Touch electronic  
For 1 – 12 CVD-Touch electronic units with mains adapter 230 V, 9 V  
Item No. 01 583 00 99



SCHELL universal connecting cable  
Length of cable 5 m,  
Item No. 01 570 00 99  
Length of cable 10 m,  
Item No. 01 571 00 99



Key switch for thermal disinfection  
Item No. 01 538 00 99

### Electronic connection for battery mode

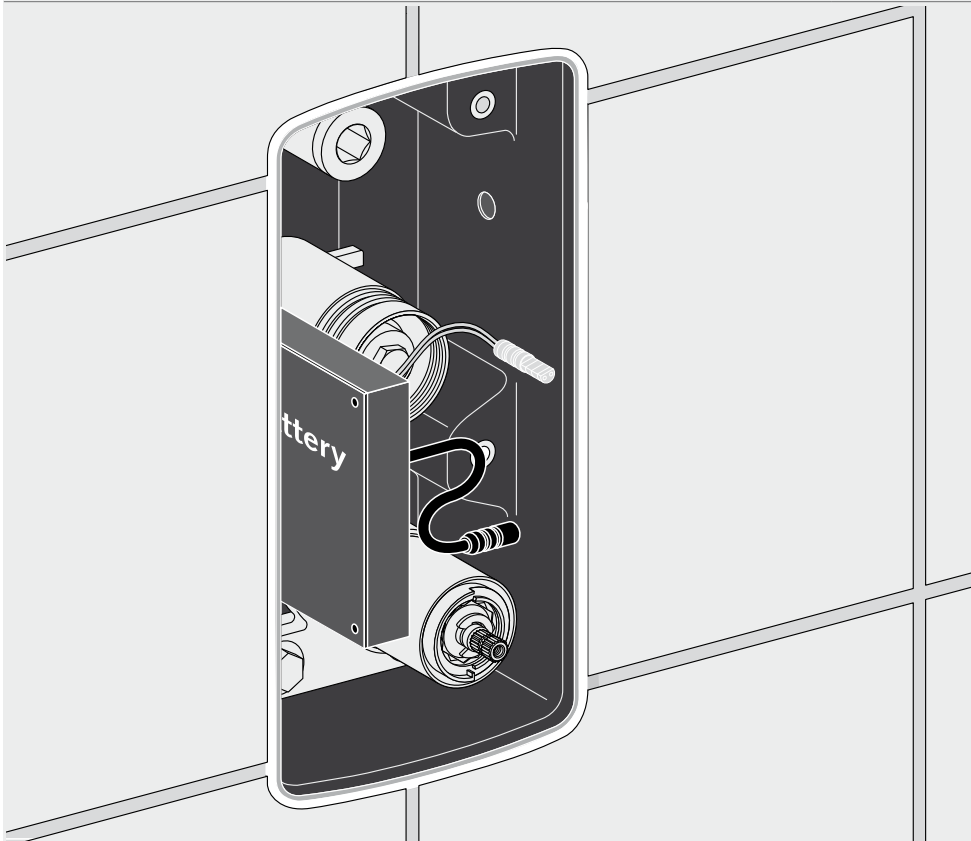

Fig. 3  
SCHELL universal battery  
compartment 6 V  
Item No. 01 557 00 99

Install the battery compartment (Fig. 3) into the Masterbox from the side (refer to diagram). All cables are correctly preassembled with plugs. If it is necessary to replace a battery (4x1.5 AA), it is indicated by the flashing red diode on the CVD-Touch electronic.

### Stagnation flush program

Drinking water in public, semi-public and commercial sanitary rooms always has top priority. Also if there are longer periods of interruption during operation, a regular exchange of the drinking water reduces the risk of bacterial contamination (e.g. legionella contamination) in the pipes.

By switching the stagnation flush program (flow 20 s/24 h, factory setting)\*, the CVD-Touch electronic ensures that bacterial contamination is reduced to a minimum.

\* For larger volumes of water in the supply pipe, on request, the stagnation flush duration and stagnation flush intervals can be changed.



Type: LINUS D-C-M



Masterbox WBD-C-M

## SHELL concealed shower LINUS D-C-M + Masterbox

### Features

Self-closing shower fitting finishing set incl. concealed Masterbox WBD-E-M with sealed casing fairleads. Prepared for operation with universal battery compartment or SCHELL CVD-Touch mains adapters. Electronics with selectable stagnation flush program\*.

### Technical Data

<b>Finishing set, Type</b>	<b>LINUS D-C-M</b>
<b>Function</b>	Self-closing mixed water
<b>Flow time setting**</b>	Flow time setting of 10 to 360 s in 10 program levels
<b>Temperature range</b>	5 – 45 °C (70 °C short-time use)
<b>Dimensions H,B,T</b>	188 mm × 180 mm × 11,5 mm
<b>Hygienic flush</b>	Hygiene flush 24 h after last use, selectable (duration of flow 20s)
<b>Material</b>	Front panel made from chrome-plated brass/stainless steel, actuation and spout made from chrome-plated brass
<b>Settings</b>	Special times for flow, duration of stagnation flush and intervals on request

<b>Corresponding Masterbox</b>	<b>WBD-E-M</b>
<b>Function</b>	On / Off / Time limit mixed water
<b>Flow time setting</b>	10 – 360 s
<b>Temperature range</b>	5–45 °C (70 °C, short-time use)
<b>Dimensions H,W,D</b>	149 mm × 138 mm × 120 mm
<b>Installation depth</b>	100 mm – 104 mm
<b>Flow pressure</b>	1.0–5.0 bar
<b>Flow rate</b>	≤ 15 l/min at 3 bar flow pressure
<b>Water connections</b>	G 1/2 IG
<b>Noise insulation class</b>	I
<b>Test symbol</b>	P-IX 18008/IA, Belgaqua
<b>Material</b>	Water path made from dezincification-resistant brass Supply connections of red brass

\* Stagnation flush program set at factory, duration of flow 20 s/24 h flush.  
Special times for duration of stagnation flush and intervals on request and  
\*\* Flow time setting on request

**Scope of delivery, finishing set LINUS D-C-M**

- Front panel
- Actuating button for mixed water with spout
- CVD-Touch electronic protected from spray water
- Mounting frame with attachment material

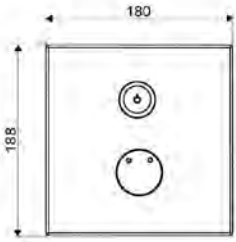

**Designs finishing set LINUS D-C-M**

Chrome front panel	Item No. 01 919 06 99
Stainless steel front panel	Item No. 01 919 28 99

**Scope of delivery Masterbox WBD-E-M**

- Fitting casing with: pre-filter, isolating valve, backflow preventer
- Concealed box
- Electronic cartridge solenoid valve 6V
- Attachment material
- Through-flow connection piece
- Protective cover

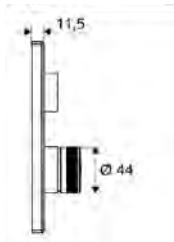

Masterbox WBD-C-M	Item No. 01 867 00 99
-------------------	-----------------------

**Recommended accessories (for dry construction mounting)**

Spray water adhesive flange (Dimensions: 425 mm × 425 mm)	Item No. 01 857 00 99
--	-----------------------

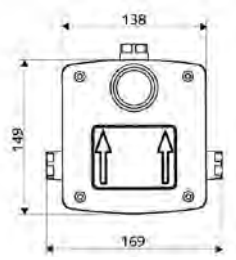

**Accessories for all types**

Shower mounting module LINUS	Item No. 03 257 00 99
Wall bracket kit (wall-mounted installation)	Item No. 03 258 00 99
Concealed mains adapter 100–240 V, 50–60 Hz, 9 V for 1–12 fittings	Item No. 01 566 00 99
Mains adapter 100–240 V, 50–60 Hz, 9 V for 1–12 fittings	Item No. 01 490 00 99
Electric junction box with mains adapter 100 – 240 V, 50/60 Hz, 12 V for 1–12 fittings	Item No. 01 537 00 99
Universal connecting cable 5 m	Item No. 01 570 00 99
Universal connecting cable 10 m	Item No. 01 571 00 99
Universal battery compartment	Item No. 01 557 00 99
Shower head BASIC	Item No. 01 844 06 99
Shower head low-aerosol	Item No. 01 814 00 99

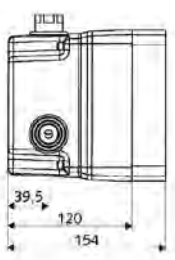

Concealed solutions



Type: LINUS D-C-T



Type: LINUS BASIC D-C-T



Masterbox WBD-E-T

### Concealed shower LINUS D-C-T/BASIC D-C-T + Masterbox

#### Features

CVD-Touch electronic shower fitting finishing set incl. concealed-Masterbox WBD-E-T with sealed casing fairleads. Prepared for operation with universal battery compartment or SCHELL CVD-Touch mains adapters. Electronics with selectable stagnation flush program\*.

#### Technical Data

Finishing set, Type	LINUS D-C-T	LINUS BASIC D-C-T
<b>Function</b>	CVD-Touch electronic On/Off/ Time limit thermostat	CVD-Touch electronic On/Off/ Time limit thermostat
<b>Flow time setting**</b>	Flow time settings of 10 to 360 s in 10 program levels	
<b>Temperature range</b>	Thermostat actuation with hot water stop at 38 °C	Thermostat actuation with hot water stop at 38 °C
<b>Dimensions H,W,D</b>	281 mm × 173 mm × 11.5 mm	283 mm × 183 mm × 3 mm
<b>Hygienic flush</b>	Hygiene flush 24 h after last use, selectable (duration of flow 20s)	
<b>Material</b>	Front panel made from chrome-plated brass/stainless steel, actuation and spout made from chrome-plated brass	Front panel made from stainless steel / actuation and spout made from chrome-plated brass
<b>Settings</b>	Special times for flow, duration of stagnation flush and intervals on request	

#### Actuation

Water ON

Water OFF

Corresponding Masterbox	WBD-E-T
<b>Function</b>	Electronic-thermostat
<b>Flow time setting</b>	About electronic module finishing set
<b>Temperature range</b>	5 - 45 °C (70 °C, short-time use)
<b>Dimensions</b>	246 mm × 112 mm × 125 mm
<b>Installation depth</b>	88 mm – 112 mm
<b>Flow pressure</b>	1,0–5,0 bar
<b>Flow rate</b>	18 l/min
<b>Water connections</b>	3 × G 1/2 IG (DIN ISO 228-1)
<b>Noise insulation class</b>	I
<b>Test symbol</b>	P-IX 18001/IA, Belgaqua
<b>Material</b>	Water path made from dezincification-resistant brass Supply connections of red brass

\* Stagnation flush program set at factory, duration of flow 20 s/24 h flush.  
Special times for duration of stagnation flush and intervals on request and

\*\* Flow time setting on request



Scope of delivery finishing set LINUS D-C-T / LINUS BASIC D-C-T	
<ul style="list-style-type: none"> <li>• Front panel</li> <li>• CVD-Touch electronic protected from spray water</li> <li>• Actuating button for thermostat valve with spout and hot water stop at 38 °C</li> <li>• Locking disc for maximum temperature limiting (protection against scalding)</li> <li>• Attachment material</li> </ul>	

Versions	
LINUS D-C-T, chrome	Item No. 01 818 06 99
LINUS D-C-T, stainless steel	Item No. 01 918 28 99
LINUS BASIC D-C-T, stainless steel	Item No. 01 909 28 99

Scope of delivery Masterbox WBD-E-T	
<ul style="list-style-type: none"> <li>• Fitting casing with: pre-filter, isolating valve, backflow preventer</li> <li>• Concealed box</li> <li>• Electronic cartridge solenoid valve</li> <li>• Thermostat cartridge in accordance with EN 1111 with changeable 38 °C temperature lock and safety lock in the event of failure of cold water, with spout</li> <li>• Attachment material</li> <li>• Through-flow connection piece</li> <li>• Protective cover</li> </ul>	

Masterbox WBD-E-T	Item No. 01 802 00 99
-------------------	-----------------------

Recommended accessories (for dry construction mounting)	
Spray water adhesive flange (Dimensions: 425 mm × 425 mm)	Item No. 01 856 00 99

Accessories for all types	
Shower mounting module LINUS	Item No. 03 257 00 99
Wall mounting set (wall-mounted installation)	Item No. 03 258 00 99
Mains adapter 100–240 V, 50/-60 Hz, 9 V for 1–12 fittings	Item No. 01 315 00 99
Mains adapter 100–240 V, 50/-60 Hz, 9 V for 1–12 fittings	Item No. 01 582 00 99
Electric junction box with mains adapter 100 – 240 V, 50/60 Hz, 12 V for 1–12 fittings	Item No. 01 583 00 99
Universal connecting cable 5 m	Item No. 01 570 00 99
Universal connecting cable, 10 m	Item No. 01 574 00 99
Universal battery compartment	Item No. 01 557 00 99
Shower head BASIC	Item No. 01 844 06 99
Shower head low-aerosol	Item No. 01 814 00 99

For thermal disinfection	
Key switch	Item No. 03 258 00 99
Monostable solenoid valve 12 V	Item No. 01 875 00 99
Concealed mains adapter 100 – 240 V, 50/60 Hz, 12 V for 1–2 solenoid valves	Item No. 01 566 00 99
Mains adapter 100–240 V, 50/60 Hz, 12 V for 1–12 solenoid valves	Item No. 01 490 00 99
Electric junction box with mains adapter 100 – 240 V, 50/60 Hz, 12 V for 1–12 solenoid valves	Item No. 01 537 00 99

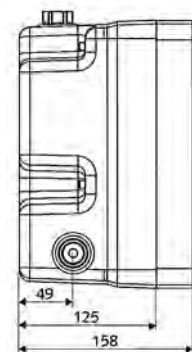
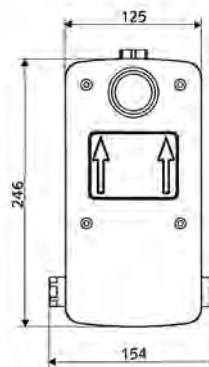
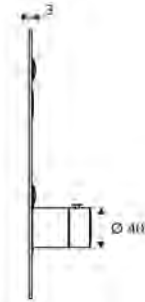
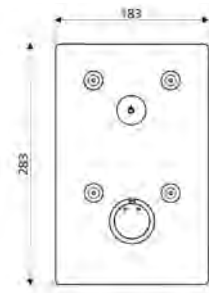

 SCHELL



Temperature mixing of the shower fittings with self-closing cartridge is particularly easy to operate, also with wet hands.

## Shower fittings with self-closing cartridge. By SCHELL. Clever and versatile.

With its puristic, clear shape, the SCHELL shower fittings with self-closing cartridge bestow a special character upon every shower area. Reliable operation and easy control are just as self-evident as is protection against vandalism. The compact front panels comprise of either chrome-plated brass or brushed stainless steel. The operating elements are made from chrome-plated brass. Whether designed for mixed water or pre-mixed water,

whether as the entry-level solution "LINUS BASIC" or as the classical design "LINUS" – SCHELL provides a sophisticated range for every application.

Shower fittings with self-closing cartridge are particularly suitable for:

- Swimming pools
- Sports facilities
- Schools
- Camping sites
- Youth hostels
- Motorway service stations
- Company shower facilities
- and much more

---

### Shower fittings with self-closing cartridge available:

#### 1. For mixed water or pre-mixed water



LINUS BASIC D-SC-M



LINUS D-SC-M/D-SC-V

#### 2. With thermostat control



LINUS BASIC D-SC-T



LINUS D-SC-T

### Fitting concept for mixed water and pre-mixed water

The water path, made from dezincification-resistant brass, is permanently connected to the Masterbox and contains all functional components for the fitting. The connections for cold and hot water are made of stress crack resistant red brass and have a female thread for easy mounting. A through-flow connection is supplied with the fitting. This is installed before commissioning the filter connections and is used to flush the system. The pressure test between the shower head connection with the fitting must be carried out separately to the pressure test for the cold and hot water connections. Depending on the configuration of the fitting, either a self-closing cartridge SC-M or SC-V is installed.

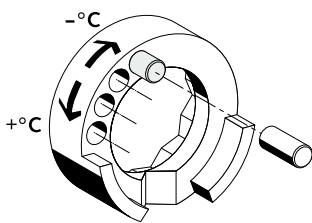

Limit pin

### Limiting the mixed-water temperature

With the mixed-water variant D-SC-M, the volume of water can be limited using a limit pin. However, this is not the same as protection against scalding because, e.g. if the cold water supply fails, the high hot water temperatures could result to scalding. As a safety measure, a central thermostat is used which is also provided for the designs D-SC-V and D-E-V, unless only cold water should be delivered at the shower head.

### High operational reliability

Core of the LINUS concealed Masterbox SC is the innovative SCHELL cartridge technology SC II. It also operates with very low actuation forces and regulates mixed water very easily. The self-closing cartridge, made from corrosion-resistant high-performance POM plastic, with automatic nozzle cleaning pin ensures continuous operation and very effective sealing.



- 1 Stainless steel spindle with receptacle for mixed-water handle (SC-M)
- 2 Piston chamber
- 3 Mixed-water temperature control (SC-M)
- 4 Hot water inlet
- 5 Cold water inlet
- 6 Mixed water outlet channel
- 7 Flow time setting

### IMPORTANT!

During the construction phase, the fittings must also be protected against contamination, to prevent contamination of the drinking water system.

**Note: Only applicable for the self-closing fittings with SC II cartridge**

A function check of all fittings is carried out at the factory and set to a flow time of approx. 20 - 25 s for the following values:

1. Flow pressure: 3 bar
2. Mixed water temperature: 38 °C
3. Flow rate at the shower head: 9 l/min

Different pressures, flow rates and temperature changes result in different flow times:

1. Changing the flow times by changing the flow pressure

Higher pressure - shorter flow time

Lower pressure - longer flow time



2. Change in flow times due to other flow rates

Lower flow rate - shorter flow time

Higher flow rate - longer flow time



3. Change in flow times due to temperature changes

Lower temperature - longer flow time

Higher temperature - shorter flow time

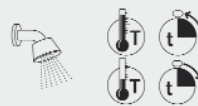

Flow time setting for WBD-SC-M

- Factory setting approx. 20–25 s (3 bar flow pressure 35 °C)
- Adjustment range approx. 5–40 s

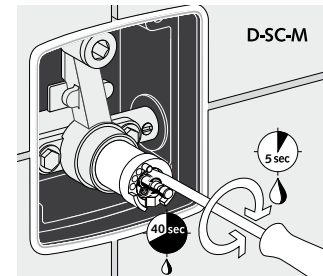

**Extension if installation is too low**

If the fitting is installed too low, this can be compensated by the available extension kits.

Example: D-SC-M

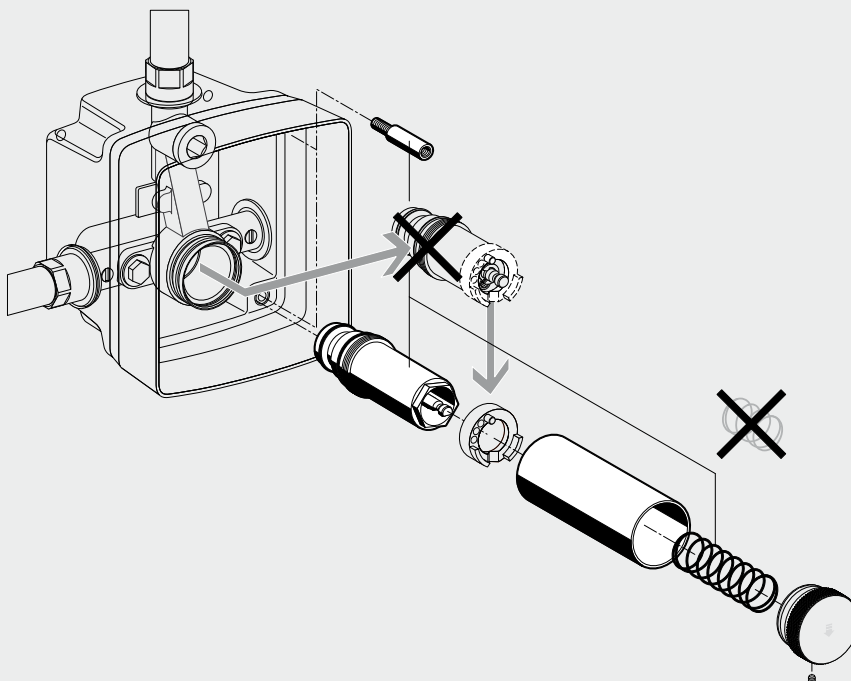

Extension cartridge D-SC-M  
 Item No. 29 648 06 99 (25 mm)  
 Item No. 29 649 06 99 (50 mm)

**Later conversion to an electronic fitting**

The components of the shower fittings can be subsequently converted, e.g. to battery-operated standard electronics (fitting for pre-mixed water).

Further information for planning on Page 30/38



Type: LINUS BASIC D-SC-M

### SCHELL concealed shower LINUS BASIC D-SC-M + Masterbox

#### Features

Self-closing shower fitting finishing set incl. concealed Masterbox WBD-SC-M with sealed casing fairleads.

#### Technical Data

<b>Finishing set, Type</b>	<b>LINUS BASIC D-SC-M</b>
<b>Function</b>	Self-closing mixed water
<b>Dimensions H,W,D</b>	190 mm × 190 mm × 3 mm
<b>Material</b>	Front panel made from stainless steel/actuation and spout made from chrome-plated brass



Masterbox WBD-SC-M

<b>Corresponding Masterbox</b>	<b>WBD-SC-M</b>
<b>Function</b>	Self-closing mixed water
<b>Flow time setting</b>	5–40 s (regulating needle)
<b>Temperature range</b>	5–45 °C (70 °C, short-time use)
<b>Dimensions</b>	149 mm × 138 mm × 120 mm
<b>Installation depth</b>	80 mm – 104 mm
<b>Flow pressure</b>	1.0–5.0 bar
<b>Flow rate</b>	≤ 15 l/min at 3 bar flow pressure
<b>Water connections</b>	G 1/2 IG
<b>Noise class</b>	I
<b>Test symbol</b>	P-IX 18008/IA, Belgaqua
<b>Material</b>	Water path made from dezincification-resistant brass Supply connections of red brass

**Scope of delivery finishing set LINUS BASIC D-SC-M**

- Front panel
- Self-closing head SC-M with spout
- Attachment accessories

**Design**

LINUS BASIC D-SC-M	Item No. 01 902 28 99
--------------------	-----------------------

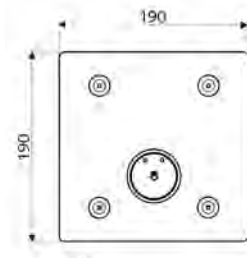

**Scope of delivery, Masterbox WBD-SC-M**

- Fitting casing with: pre-filter, isolating valve, backflow preventer
- Concealed box
- Self-closing cartridge SC-M
- Attachment material
- Through-flow connection
- Protective cover

**Versions**

WBD-SC-M	Item No. 01 867 00 99
----------	-----------------------

**Recommended accessories (for dry construction mounting)**

Spray water adhesive flange (Dimensions: 425 mm x 425 mm)	Item No. 01 857 00 99
--	-----------------------

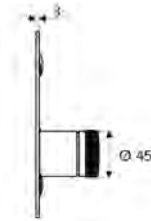

**Accessories for all types**

Shower mounting module LINUS	Item No. 03 257 00 99
Wall bracket kit (wall-mounted installation)	Item No. 03 258 00 99
Extension cartridge 25 mm for D-SC-M	Item No. 29 648 06 99
Extension cartridge 50 mm for D-SC-M	Item No. 29 649 06 99
Shower head BASIC	Item No. 01 844 06 99
Shower head low-aerosol	Item No. 01 814 00 99

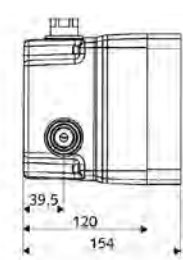
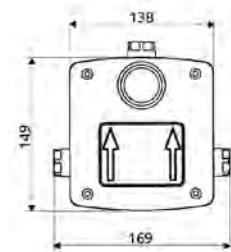

Concealed solutions



Type: LINUS D-SC-M



Type: LINUS D-SC-V



Masterbox WBD-C-M/WBD-C-V

## SHELL concealed shower LINUS D-SC-M/D-SC-V + Masterbox

### Features

Self-closing shower fitting finishing set incl. concealed Masterbox D-SC-M/WBD-SC-V with sealed casing fairleads.

### Technical Data

Finishing set, Type	LINUS D-SC-M	LINUS D-SC-V
Function	Self-closing mixed water	Self-closing - pre-mixed/ cold water
Dimensions H,W,D	188 mm × 180 mm × 11,5 mm	
Material	Front panel made from stainless steel/actuation and spout made from chrome-plated brass	Front panel stainless steel/actuation, draw-off and spout made from chrome-plated brass

### Technical Data

Corresponding Masterbox	WBD-SC-M	WBD-SC-V
Function	Self-closing mixed water	Self-closing - pre-mixed/ cold water
Flow time setting	5–40 s (regulating needle)	
Temperature range	5–45 °C (70 °C short-time use)	Pre-mixed water
Dimensions H,W,D	149 mm × 138 mm × 120 mm	
Installation depth	80 mm – 104 mm	
Flow pressure	1.0–5.0 bar	
Flow rate	≤ 15 l/min at 3 bar flow pressure	
Water connections	G 1/2 IG	
Noise class	I	
Test symbol	P-IX 18008/IA, Belgaqua	
Material	Water path made from dezincification-resistant brass Supply connections of red brass	



Scope of delivery finishing set LINUS D-SC-M / D-SC-V	
<ul style="list-style-type: none"> <li>• Front panel</li> <li>• Self-closing button with spout (with temperature limiting SC-M)</li> <li>• Mounting frame with attachment material</li> </ul>	

Designs of finishing set		
	LINUS D-SC-M	LINUS D-SC-V
Chrome front panel	Item No. 01 832 06 99	Item No. 01 833 06 99
Stainless steel front panel	Item No. 01 832 28 99	Item No. 01 833 28 99

Scope of delivery, Masterbox WBD-SC-M / WBD-SC-V	
<ul style="list-style-type: none"> <li>• Fitting casing with: pre-filter, isolating valve, backflow preventer</li> <li>• Concealed box</li> <li>• Self-closing cartridge SC-M / SC-V</li> <li>• Attachment material</li> <li>• Through-flow connection</li> <li>• Protective cover</li> </ul>	

Masterbox WBD-SC-M	Item No. 01 867 00 99
Masterbox WBD-SC-V	Item No. 01 827 00 99

**Recommended accessories (for dry construction mounting)**

Spray water adhesive flange (Dimensions: 425 mm × 425 mm)	Item No. 01 857 00 99
--	-----------------------

**Accessories for all types**

Shower mounting module LINUS	Item No. 03 257 00 99
Wall bracket kit (wall-mounted installation)	Item No. 03 258 00 99
Extension cartridge 25 mm for D-SC-M	Item No. 29 648 06 99
Extension cartridge 25 mm for D-SC-V	Item No. 01 872 06 99
Extension cartridge 50 mm for D-SC-M	Item No. 29 649 06 99
Extension cartridge 50 mm for D-SC-V	Item No. 01 873 06 99
Shower head BASIC	Item No. 01 844 06 99
Shower head low-aerosol	Item No. 01 814 00 99

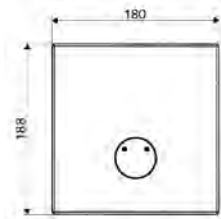

Type: LINUS D-SC-M

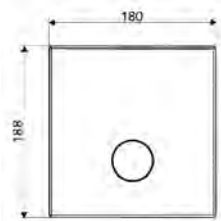

Type: LINUS D-SC-V

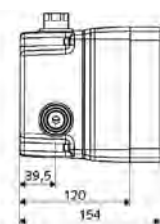
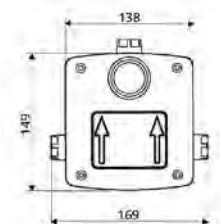
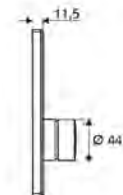



Type: LINUS Basic D-SC-T



Masterbox WBD-SC-T

## SCHELL concealed shower LINUS BASIC D-SC-T + Masterbox

### Features

Self-closing fitting with thermostat-controlled temperature control – Finishing set including concealed Masterbox WBD-SC-T with sealed casing fairleads

- Thermal disinfection can be retrofitted

### Technical Data

<b>Finishing set, Type</b>	<b>LINUS BASIC D-SC-T</b>
<b>Function</b>	Self-closing thermostat
<b>Temperature range</b>	Thermostat actuation with hot water stop at 38 °C
<b>Dimensions H,W,D</b>	Dimensions 183 mm × 283 mm × 3 mm
<b>Material</b>	Front panel made from brushed stainless steel/actuation and spout made from chrome-plated brass

<b>Corresponding Masterbox</b>	<b>WBD-SC-T</b>
<b>Function</b>	Self-closing thermostat
<b>Flow time setting</b>	5–40 s
<b>Temperature range</b>	5–45 °C (70 °C, short-time use)
<b>Dimensions</b>	122 mm × 246 mm × 125 mm
<b>Installation depth</b>	88 mm – 112 mm
<b>Flow pressure</b>	1,5–5,0 bar
<b>Flow rate</b>	15 l/min at 3.0 bar flow pressure
<b>Water connections</b>	3 × G 1/2 IG (DIN ISO 288-1)
<b>Noise class</b>	I
<b>Test symbol</b>	P-IX 18001/IA, Belgaqua
<b>Material</b>	Water path made from dezincification-resistant brass Supply connections of red brass

**Scope of delivery finishing set LINUS BASIC D-SC-T**

- Front panel
- Self-closing button SC-V with spout
- Actuating button for thermostat valve with spout and hot water stop at 38 °C
- Locking disc for maximum temperature limiting (protection against scalding)
- Attachment accessories

<b>Design</b>	
LINUS BASIC D-SC-T	Item No. 01 900 28 99

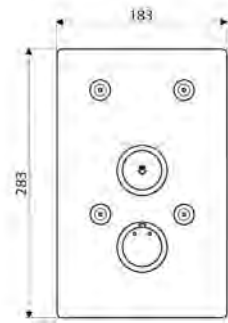

**Scope of delivery, Masterbox WBD-SC-T**

- Fitting casing with: pre-filter, isolating valve, backflow preventer
- Concealed box
- Thermostat cartridge in accordance with EN 1111 with changeable temperature lock 38 °C and safety lock in the event of failure of cold water, with spout
- Self-closing cartridge
- Attachment material
- Flush plug
- Protective cover

Masterbox WBD-SC-T	Item No. 01 800 00 99
--------------------	-----------------------

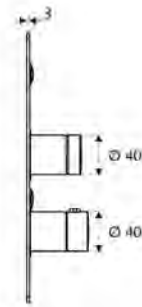

<b>Recommended accessories (for dry construction mounting)</b>	
Spray water adhesive flange (Dimensions: 425 mm x 425 mm)	Item No. 01 856 00 99

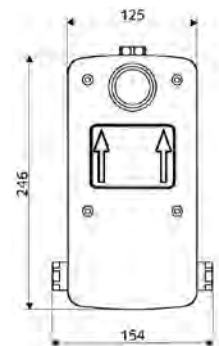

<b>Accessories for all types</b>	
Shower mounting module LINUS	Item No. 03 257 00 99
Wall mounting set (wall-mounted installation)	Item No. 03 258 00 99
Mains adapter 230 V, 50/60 Hz, 9 V for 1–2 connections	Item No. 01 491 00 99
Mains adapter 100–240 V, 50/60 Hz, 12 V for 1–12 connections	Item No. 01 490 00 99
Electric junction box	Item No. 01 537 00 99
Extension cartridge 25 mm for D-SC-T	Item No. 01 859 06 99
Extension cartridge 50 mm for D-SC-T	Item No. 01 863 06 99
Shower head BASIC	Item No. 01 844 06 99
Shower head low-aerosol	Item No. 01 814 00 99

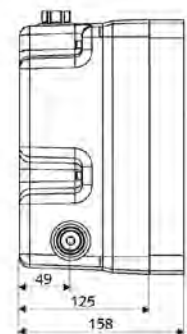

<b>For thermal disinfection</b>	
Key switch	Item No. 03 258 00 99
Monostable solenoid valve 12 V	Item No. 01 875 00 99
Concealed mains adapter 100 – 240 V, 50/60 Hz, 12 V for 1–2 solenoid valves	Item No. 01 566 00 99
Mains adapter 100–240 V, 50/60 Hz, 12 V for 1–12 solenoid valves	Item No. 01 490 00 99
Electric junction box with mains adapter 100 – 240 V, 50/60 Hz, 12 V for 1–12 solenoid valves	Item No. 01 537 00 99



Type: LINUS BASIC D-SC-T



Masterbox WBD-SC-T

## SCHELL concealed shower LINUS D-SC-T + Masterbox

### Features

Self-closing shower fitting finishing set incl. concealed-Masterbox WBD-SC-T with sealed casing fairleads.

### Technical Data

<b>Finishing set, Type</b>	<b>LINUS D-SC-T</b>
<b>Function</b>	Self-closing thermostat
<b>Flow time setting</b>	10–30 s
<b>Temperature range</b>	Thermostat actuation with hot water stop at 38 °C
<b>Dimensions H,W,D</b>	Dimensions 281 mm × 173 mm × 11.5 mm
<b>Material</b>	Front-facing panel made of stainless steel Operating elements, spouts made of chrome-plated brass

<b>Corresponding Masterbox</b>	<b>WBD-SC-T</b>
<b>Function</b>	Self-closing thermostat
<b>Flow time setting</b>	5–40 s
<b>Temperature range</b>	5–45 °C (70 °C, short-time use)
<b>Dimensions</b>	122 mm × 246 mm × 125 mm
<b>Installation depth</b>	88 mm– 112 mm
<b>Flow pressure</b>	1,5–5,0 bar
<b>Flow rate</b>	15 l/min at 3.0 bar flow pressure
<b>Water connections</b>	3 × G 1/2 IG (DIN ISO 288-1)
<b>Noise class</b>	I
<b>Test symbol</b>	P-IX 18001/IA, Belgaqua
<b>Material</b>	Water path made from dezincification-resistant brass Supply connections of red brass

**Scope of delivery finishing set LINUS D-SC-T**

- Front panel
- Mounting frame with attachment material
- Self-closing button SC-V with spout
- Actuating button for thermostat valve with spout and hot water stop at 38 °C
- Locking disc for maximum temperature limiting (protection against scalding)

**Designs finishing set LINUS D-SC-T**

Chrome front panel	Item No. 01 809 06 99
Stainless steel front panel	Item No. 01 809 28 99

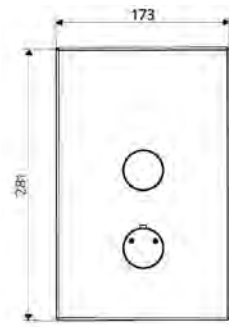

**Scope of delivery, Masterbox WBD-SC-T**

- Fitting casing with: pre-filter, isolating valve, backflow preventer
- Concealed box
- Thermostat cartridge in accordance with EN 1111 with changeable temperature lock 38 °C and safety lock in the event of failure of cold water, with spout
- Self-closing cartridge
- Attachment material
- Flush plug
- Protective cover

Masterbox WBD-SC-T	Item No. 01 800 00 99
--------------------	-----------------------

**Recommended accessories (for dry construction mounting)**

Spray water adhesive flange (Dimensions: 425 mm × 425 mm)	Item No. 01 856 00 99
--	-----------------------

**Accessories for all types**

Shower mounting module LINUS	Item No. 03 257 00 99
Wall mounting set (wall-mounted installation)	Item No. 03 258 00 99
Mains adapter 230 V, 50/60 Hz, 9 V for 1–2 connections	Item No. 01 491 00 99
Mains adapter 100–240 V, 50/60 Hz, 12 V for 1–12 connections	Item No. 01 490 00 99
Electric junction box	Item No. 01 537 00 99
Extension cartridge 25 mm for D-SC-T	Item No. 01 859 06 99
Extension cartridge 50 mm for D-SC-T	Item No. 01 863 06 99
Shower head BASIC	Item No. 01 844 06 99
Shower head low-aerosol	Item No. 01 814 00 99

**For thermal disinfection**

Key switch	Item No. 03 258 00 99
Monostable solenoid valve 12 V	Item No. 01 875 00 99
Concealed mains adapter 100 – 240 V, 50/60 Hz, 12 V for 1–2 solenoid valves	Item No. 01 566 00 99
Mains adapter 100–240 V, 50/60 Hz, 12 V for 1–12 solenoid valves	Item No. 01 490 00 99
Electric junction box with mains adapter 100 – 240 V, 50/60 Hz, 12 V for 1–12 solenoid valves	Item No. 01 537 00 99

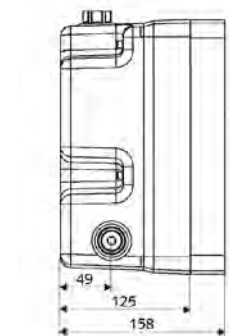
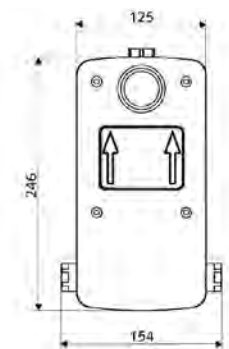
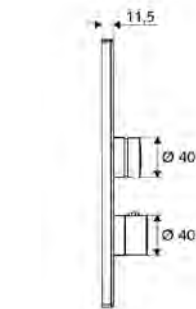



- With SCHELL single-lever mixers, the required temperature can be regulated in comfort and also water-saving.

## Single-lever shower fitting. By SCHELL. Everything under control.

The SCHELL range of shower fittings is rounded off with the single-lever solution. Thus, the fitting specialist offers an unprecedented, wide range of products for public, semi-public and commercial sanitary rooms. What architects, planners and users of the single-lever design particularly value in the LINUS family of products, in addition to the elegant design: the high-quality materials, such as the stainless steel front panel and

actuation fittings and spout made from brass. Further advantages: the easy mounting, the high reliability of the ceramic cartridge and ease of operation. What else does one require.

Single-lever shower fittings are particularly suitable for:

- Hotels
- Hotel spas and leisure pools
- Sports facilities
- Private bathrooms
- and much more.



Type: LINUS D-EM-M



Masterbox WBD-EM-M

## SCHELL concealed shower LINUS D-EH-M + Masterbox

### Features

Single-lever shower fitting finishing set incl. concealed Masterbox WBD-EH-M, fitting preassembled in a plastic concealed box with sealed casing fairings.

### Technical Data

<b>Finishing set, Type</b>	<b>D-EH-M</b>
<b>Function</b>	Single-lever mixed water
<b>Dimensions H,W,D</b>	188 mm × 180 mm × 11.5 mm
<b>Material</b>	Front panel made from stainless steel/actuation and spout made from chrome-plated brass

<b>Corresponding Masterbox</b>	<b>WBD-EH-M</b>
<b>Function</b>	Single-lever mixed water
<b>Temperature range</b>	5–45 °C (70 °C, short-time use)
<b>Dimensions</b>	149 mm × 138 mm × 120 mm
<b>Installation depth</b>	80 mm – 104 mm
<b>Flow pressure</b>	1.0–5.0 bar
<b>Flow rate</b>	≤ 15 l/min at 3 bar flow pressure
<b>Water connections</b>	G 1/2 IG
<b>Noise class</b>	I
<b>Test symbol</b>	P-IX 18008/IA, Belgaqua
<b>Material</b>	Water path made from dezincification-resistant brass Supply connections of red brass



Scope of delivery finishing set LINUS D-EH-M	
<ul style="list-style-type: none"> <li>• Front panel</li> <li>• Mounting frame with attachment material</li> <li>• Single lever handle with spout</li> </ul>	

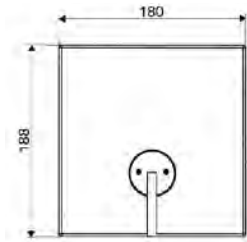

Designs finishing set LINUS D-EH-M	
Chrome front panel	Item No. 01 896 06 99
Stainless steel front panel	Item No. 01 896 28 99

Scope of delivery, Masterbox WBD-EH-M	
<ul style="list-style-type: none"> <li>• Fitting casing with: pre-filter, isolating valve, backflow preventer</li> <li>• Concealed box</li> <li>• Single-lever ceramic cartridge with hot water limiting, adjustable and variable volume limiting</li> <li>• Attachment material</li> <li>• Through-flow connection</li> <li>• Protective cover</li> </ul>	

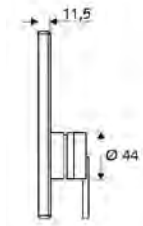

Masterbox WBD-EH-M	Item No. 01 891 00 99
--------------------	-----------------------

Recommended accessories (for dry construction mounting)	
Spray water adhesive flange (Dimensions: 425 mm x 425 mm)	Item No. 01 857 00 99

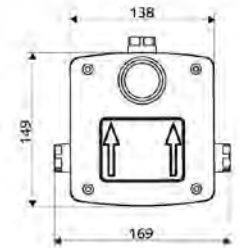

Accessories for all types	
Shower mounting module LINUS	Item No. 03 257 00 99
Wall mounting set (wall-mounted installation)	Item No. 03 258 00 99
Shower head BASIC	Item No. 01 844 06 99
Shower head low-aerosol	Item No. 01 814 00 99

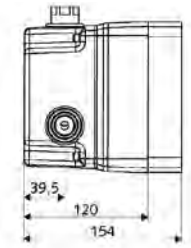



## Wall-mounted showers

---



---

LINUS DP-SC-M  
Page 62

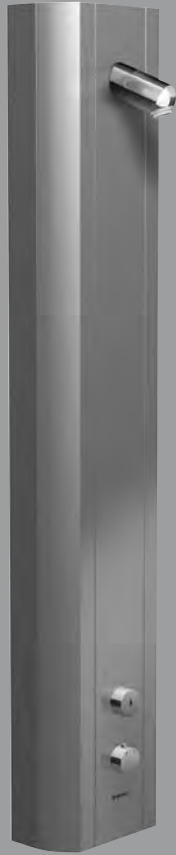

---

LINUS DP-SC-T  
Page 63



---

LINUS DP-C-T  
Page 64

LINUS DP-SC-V  
Page 62



• The robust aluminium body and chrome-plated actuation fittings of the LINUS shower panels brave the hard daily use in public sanitary rooms.

SCHHELL

## Wall-mounted shower panels. By SCHELL.

Elegant, durable and easy to mount.

Functionality, design and mounting – SCHELL shower panels have everything you need. The solid, corrosion-protected aluminium extruded profile with a polished anodized, easy-to-maintain surface, bestows high aesthetic value upon you and ensures a long service life. Even with the water-saving shower head, showering comfort is not neglected. The shower panels also have a convincing hygiene concept. The CVD-Touch control provides selectable stagnation flushing every 24 hours after the last use. In addition, the variants DP-SC-T and DP-C-T can also be supplied for

carrying out thermal disinfection.

**Practical:** SCHELL shower panels, together with the fitting and integrated shower head already mounted at the factory and, using a mounting template to save time, can be installed by a single person. Easy to connect during refurbishment. Also an option to mount on the partitions of shower cubicles, because the line can be routed from above.

Wall-mounted shower panels are particularly suitable for:

- Sports facilities
- Camping sites
- Leisure pools
- Motorway service stations
- Hotels
- Multi-accommodation
- Company shower facilities
- and much more

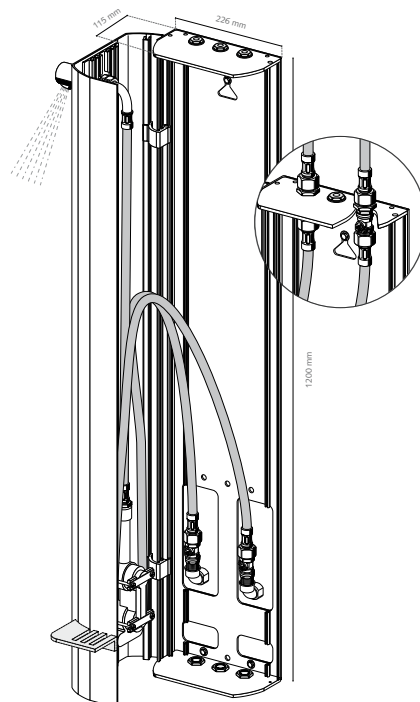

In order to ensure quick servicing, all connecting lines are installed protected behind the front panel, which can be pivoted.

Option to connect supply pipes from above

Can be connected to existing wall connections (easy servicing due to the front panel opening to the side)



LINUS DP-SC

## Mounting dimensions

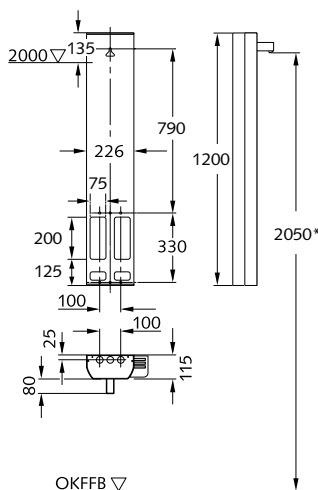

\*Recommended installation dimensions, as necessary, adapt to user requirements, e.g. children

## Wall-mounted shower panel LINUS DP-SC

## Features

Shower panel made from solid extruded aluminium profile with high-quality anodized surface and integrated SCHELL shower fitting, type: LINUS D-SC. Easy to mount and service, due to the pivoting front panel, suitable for connections from the rear and for wall-mounted connections from above.

## Technical Data

Type	DP-SC-M	DP-SC-V self-closing
Function	Self-closing mixed water	Self-closing - pre-mixed/cold water
Flow pressure	1,5–5,0 bar	1,5–5,0 bar
Flow rate, fitting	15 l/min	15 l/min
Flow rate, shower head	9 l/min, irrespective of pressure	9 l/min, irrespective of pressure
Flow time setting	5–40 s	5–40 s
Temperature range	5–45 °C (70 °C, short-time use)	Pre-mixed water
Dimensions	1200 mm × 226 mm × 115 mm	1200 mm × 226 mm × 115 mm
Test mark	P-IX 18008/IA	P-IX 18008/IA
Material	Panel made from aluminium Water path made from dezincification-resistant brass Actuating fitting made from chrome-plated brass	

## Scope of delivery

- Panel with preassembled LINUS shower fitting with integrated self-closing cartridge SC, including piping between fitting and connection to shower head
- Actuating button SC
- Shower head low-aerosol, flow rate 9 l/min independent of pressure
- Attachment material
- Connection accessories

## Versions

LINUS DP-SC-M, self-closing – mixed water	Item No. 00 803 08 99
LINUS DP-SC-V, self-closing – pre-mixed water	Item No. 00 804 08 99

## Accessories

Tray LINUS	Item No. 00 809 08 99
Pipe connection kit, shower panel, 500 mm long	Item No. 08 481 06 99
Pipe connection kit, shower panel, 1000 mm long	Item No. 08 482 06 99
Connection panel, shower panel LINUS, installation length 150–450 mm	Item No. 00 810 08 99
Connection panel, shower panel LINUS, installation length 451–950 mm	Item No. 00 812 08 99

All shower panels suitable to use with drinking water, in accordance with the 2011 revised drinking water ordinance Special applications on request.

## Wall-mounted shower panel LINUS DP-SC-T

### Features

Shower panel made from solid extruded aluminium profile with high-quality anodized surface and integrated SCHELL shower fitting, type: LINUS D-SC-T. Easy to mount and service, due to the pivoting front panel, suitable for connections from the rear and for wall-mounted connections from above. Fitting casing with additional adapter for a solenoid valve for thermal disinfection (accessories).

### Technical Data

Type	DP-SC-T Self-closing
Function	Self-closing thermostat
Flow pressure	1,5–5,0 bar
Flow rate, fitting	≤ 15 l/min
Flow rate, shower head	9 l/min, irrespective of pressure
Flow time setting	5–40 s
Temperature range	5–45 °C (70 °C, short-time use)
Dimensions	1200 mm × 226 mm × 115 mm
Test mark	P-IX 18001/IA
Material	Panel made from aluminium Water path made from dezincification-resistant brass Actuating fitting made from chrome-plated brass

### Scope of delivery

- Panel with preassembled LINUS shower fitting with integrated self-closing cartridge and thermostat cartridge, including piping between fitting and connection to shower head
- Thermostat cartridge with safety lock in the event of failure of cold water (EN 1111)
- Actuating button for thermostat valve with hot water stop at 38 °C
- Locking disc for maximum temperature limiting (protection against scalding)
- Shower head low-aerosol, flow rate 9 l/min independent of pressure
- Attachment material, connection accessories

### Versions

LINUS DP-SC-T, self-closing	Item No. 00 802 08 99
LINUS DP-SC-T, self-closing with preassembled cartridge solenoid valve for thermal disinfection	Item No. 00 815 08 99

### Accessories

Tray LINUS	Item No. 00 809 08 99
Pipe connection kit, shower panel, 500 mm long	Item No. 08 481 06 99
Pipe connection kit, shower panel, 1000 mm long	Item No. 08 482 06 99
Connection panel, shower panel LINUS, installation length 150–450 mm	Item No. 00 810 08 99
Connection panel, shower panel LINUS, installation length 451–950 mm	Item No. 00 812 08 99

### Accessories for thermal disinfection

Key switch	Item No. 01 538 00 99
------------	-----------------------



LINUS DP-SC-T

Accessories: Mains adapters for thermal disinfection



Concealed mains adapter 100 – 240 V, 50 – 60 Hz, 9 V, for 1 – 2 solenoid valves  
Item No. 01 566 00 99



Mains adapter 100 – 240 V, 50 – 60 Hz, 9 V, for 1 – 12 solenoid valves  
Item No. 01 490 00 99



Electric junction box with mains adapter 100 – 240 V, 50 – 60 Hz, 9 V, for 1 – 12 solenoid valves  
Item No. 01 537 00 99



LINUS DP-C-T

Accessories: Mains adapters,  
CVD-Touch electronic



Concealed mains adapter 100 – 240 V.  
50 – 60 Hz, 9 V, for 1 – 12 fittings  
Item No. 01 315 00 99



Mains adapter 100 – 240 V. 50 – 60 Hz,  
9 V, for 1 – 12 fittings  
Item No. 01 582 00 99



Electric junction box with mains adapter  
100 – 240 V. 50 – 60 Hz, 9 V,  
for 1 – 12 solenoid valves  
Item No. 01 583 00 99

## Wall-mounted shower panel LINUS DP-C-T

### Features

Shower panel made from solid extruded aluminium profile with high-quality anodized surface and integrated SCHELL shower fitting, type: LINUS D-SC-T. Easy to mount and service, due to the pivoting front panel, suitable for connections from the rear and for wall-mounted connections from above. Fitting casing with additional adapter for a solenoid valve for thermal disinfection (accessories).

### Technical Data

<b>Type</b>	DP-C-T
<b>Function</b>	CVD-Touch electronic On/Off/Time limit thermostat
<b>Flow pressure</b>	1,5–5,0 bar
<b>Flow rate, fitting</b>	15 l/min
<b>Flow rate, shower head</b>	9 l/min, irrespective of pressure
<b>Flow time setting</b>	10–360 s in 10 programme levels
<b>Temperature range</b>	5–45 °C (70 °C short-time use)
<b>Dimensions</b>	1200 mm × 226 mm × 115 mm
<b>Test mark</b>	P-IX 18008/IA
<b>Material</b>	Panel made from aluminium Water path made from dezincification-resistant brass Actuating fitting made from chrome-plated brass

### Scope of delivery

- Panel with preassembled LINUS shower fitting with integrated cartridge solenoid valve 6 V and thermostat cartridge, including piping between fitting and connection to shower head
- CVD-Touch electronic protected from spray water
- Thermostat cartridge with safety lock in the event of failure of cold water (EN 1111)
- Actuating button for thermostat valve with hot water stop at 38 °C
- Locking disc for maximum temperature limiting (protection against scalding)
- Shower head low-aerosol, flow rate 9 l/min independent of pressure
- Attachment material, connection accessories

### Versions

<b>CVD-Touch electronic prepared for mains/battery mode</b>	Item No. 00 819 08 99
<b>CVD-Touch electronic prepared for mains/battery mode, with preassembled cartridge solenoid valve for thermal disinfection</b>	Item No. 00 820 08 99

### Accessories required

<b>Connecting cable D-C-T 5 m long</b>	Item No. 01 570 00 99
<b>Connecting cable D-C-T 10 m long</b>	Item No. 01 571 00 99
<b>Battery compartment</b>	Item No. 01 557 00 99



Accessories	
Tray LINUS	Item No. 00 809 08 99
Pipe connection kit, shower panel, 500 mm long	Item No. 08 481 06 99
Pipe connection kit, shower panel, 1000 mm long	Item No. 08 482 06 99
Connection panel, shower panel LINUS, installation length 150–450 mm	Item No. 00 810 08 99
Connection panel, shower panel LINUS, installation length 451–950 mm	Item No. 00 812 08 99



For thermal disinfection	
Key switch	Item No. 01 538 00 99
Concealed mains adapter 100 – 240 V, 50/60 Hz, 12 V for 1–2 solenoid valves	Item No. 01 566 00 99
Mains adapter 100–240 V, 50/60 Hz, 12 V for 1–12 solenoid valves	Item No. 01 490 00 99
Electric junction box with mains adapter 100 – 240 V, 50/60 Hz, 12 V for 1–12 solenoid valves	Item No. 01 537 00 99

Drinking water in public, semi-public and commercial sanitary rooms always has top priority. Also if there are longer periods of interruption during operation, a regular exchange of the drinking water reduces the risk of bacterial contamination (e.g. legionella contamination) in the pipes.

Switching the stagnation flush program (flow rate 20 s/24 h, factory setting)\*, the CVD-Touch electronic ensures that bacterial contamination is reduced to a minimum.

\* For larger volumes of water in the supply pipe, on request, the stagnation flush duration and stagnation flush intervals can be changed.

#### Maintenance instructions for the shower panel

**Cleaning agents must be suitable for cleaning the aluminium surface.**

**Cleaning should be carried out in the following steps:**

1. Wash using water containing a wetting agent and a sponge, scrubbing brush, suitable pad
2. Carefully rub the surface using the suitable, non-abrasive cleaning agent and / or suitable pad.
3. Wash off the residual cleaning agent
4. Dry, e.g. using leather

No cleaning agent used that chemically attacks the anodized layer must get on the anodized surfaces. Fluorides, chlorides and sulphates damage the surface. The pH value of the cleaning agent must be within the chemical neutral range of between pH 5 and pH 8. Agents that are abrasive or scratch, such as sandpaper, steel wool or wire brushes are not permitted.

#### Example of cleaning agents

Application	Cleaning agent	Type of cleaning agent
Normal daily use	Terra Activ BAD from Henkel® BIFF® bath cleaner*	Liquid cleaning agent in aerosol can
Degreasing, removing adhesive, traces of rubber, fresh silicone and bitumen	Aluminium cleaning agent Type 60 from Würth®*	Solvent (solvent-based cleaning agent)
If heavily contaminated, polish	Aluminium polish from the company Alufinish GmbH®*	Washing paste cleans and forms a protective film, water runs off

\* Status of the cleaning agent 07.2011. Observe the instructions for use from the manufacturer.

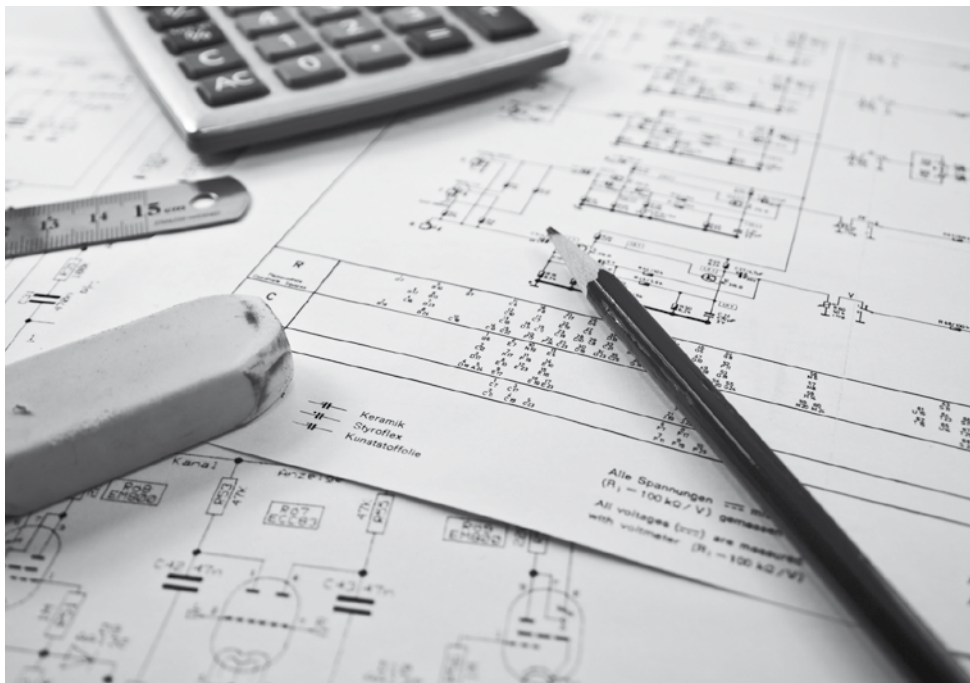

[www.schell.eu](http://www.schell.eu)

The address with which professional plans can be made. Have we sparked your interest? On our homepage, you will find much more information about our products, specifications and mounting technologies. Why not just click your way through the site!

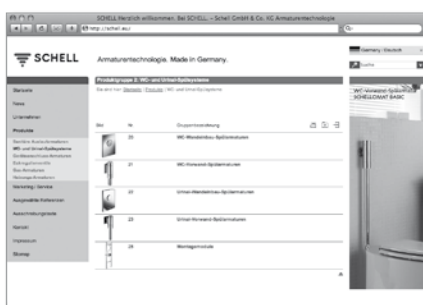

[www.schell.eu](http://www.schell.eu)

At [www.schell.eu](http://www.schell.eu), you will find all important details about our sanitary draw-off taps.



[www.ausschreiben.de](http://www.ausschreiben.de)

Online, practical and always up-to-date: Specifications by SCHELL.

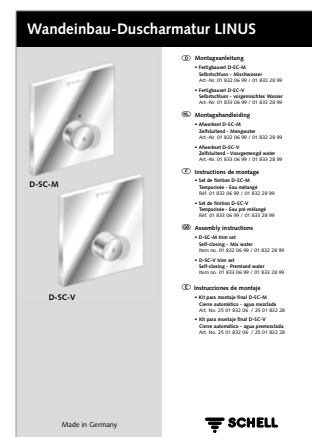

Installation instructions

Available for each individual product: The mounting instructions as a download by SCHELL.

Further information for SCHELL "General installation conditions" at [www.schell.eu](http://www.schell.eu).



**The perfect addition: important brochures about wash basin fittings by SCHELL – also available to download.**



SCHELL complete catalogue



Contemporary sanitary rooms. For public facilities

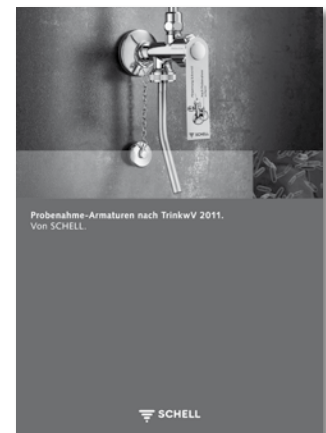

Sampling fittings in accordance with TrinkwV (German Drinking Water Regulations) 2011.



Brochure WELL Water Efficiency Labelling



Technical Manual, Washbasin fittings

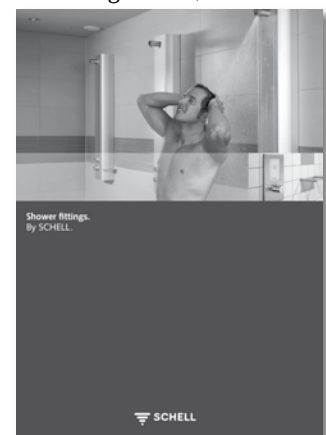

Brochure, shower fittings



SCHELL GmbH & Co. KG  
Fittings Technology  
Raiffeisenstrasse 31  
57462 Olpe  
Germany  
Tel. +49 2761 892-0  
Fax +49 2761 892-199  
info@schell.eu  
www.schell.eu

