



Paulmann

Safety Instructions

1, 2, 3, 4, 5, 6, 7, 8, 12, 13, 15, 16, 17, 18, 19, 20, 24, 28, 33, 34,



Info

www.paulmann.com

Paulmann Licht GmbH
Quezinger Feld 2
31832 Springe
Germany

www.paulmann.com

Art.-Nr.:

3725
3726

(+MA 326) PHM 04/18

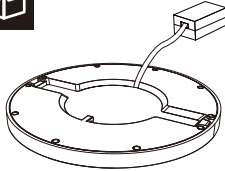

3725 6W/3726 12W

Incl.

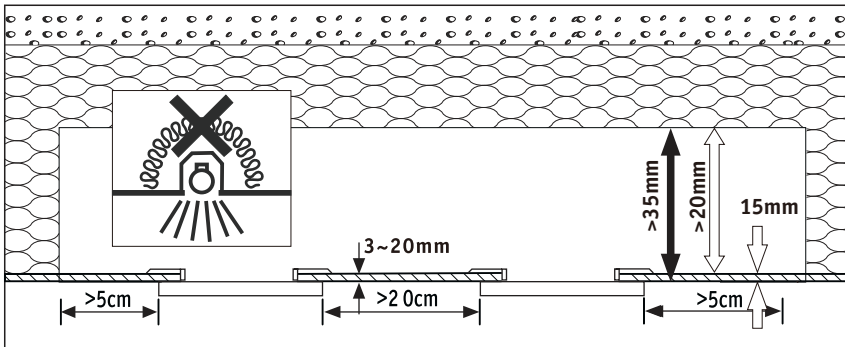
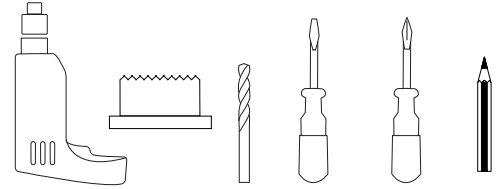
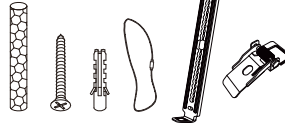

A1/A2



Safety Instructions
Nr. 4, 5, 6, 7

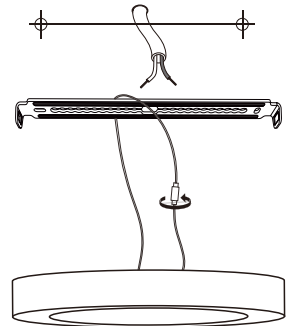
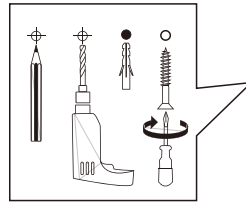

A1/A2

3725: $\varnothing 55 \sim 100 \text{mm}$
3726: $\varnothing 55 \sim 125 \text{mm}$



Safety Instructions
Nr. 4, 5, 6, 7

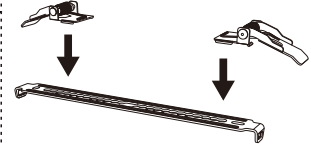
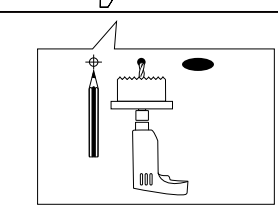

B

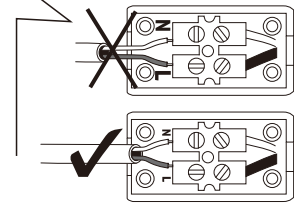
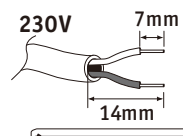
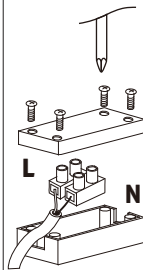

Safety Instructions
Nr. 4, 5, 6, 7

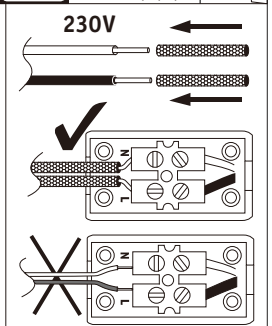

C1/C2

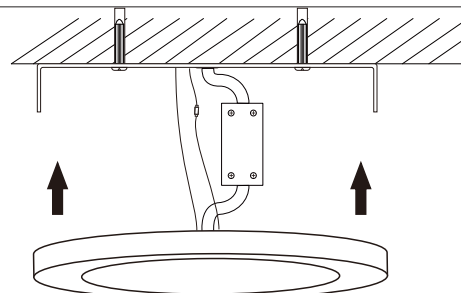

Safety Instructions
Nr. 4, 5, 6



C1/C2

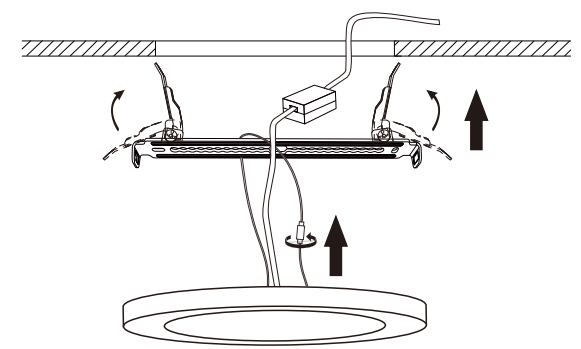

D

